

Guidance on Inspection, Repair, and Maintenance of Wooden Hulls

ENCLOSURE (1) TO NVIC 7-95
COMPILED BY THE JOINT INDUSTRY/COAST GUARD
WOODEN BOAT INSPECTION WORKING GROUP
August 1995

TABLE OF CONTENTS

ACKNOWLEDGEMENTS	A-1
LIST OF FIGURES	F-1
GLOSSARY	G-1

CHAPTER 1. DESIGN CONSIDERATIONS

A.	Introduction	1-1
B.	Acceptable Classification Society Rules	1-1
C.	Good Marine Practice	1-1

CHAPTER 2. PLAN SUBMITTAL GUIDE

A.	Introduction	2-1
B.	Plan Review	2-1
C.	Other Classification Society Rules and Standards	2-1
D.	The Five Year Rule	2-1

CHAPTER 3. MATERIALS

A.	Shipbuilding Wood	3-1
B.	Bending Woods	3-1
C.	Plywood.	3-2
D.	Wood Defects	3-3
E.	Mechanical Fastenings; Materials	3-3
F.	Screw Fastenings	3-4
G.	Nail Fastenings	3-5
H.	Boat Spikes and Drift Bolts	3-6
I.	Bolting Groups	3-7
J.	Adhesives	3-7
K.	Wood Preservatives	3-8

CHAPTER 4. GUIDE TO INSPECTION

A.	General	4-1
B.	What to Look For	4-1
C.	Structural Problems	4-1
D.	Condition of Vessel for Inspection	4-1
E.	Visual Inspection	4-2
F.	Inspection for Decay and Wood Borers	4-2
G.	Corrosion & Cathodic Protection	4-6
H.	Bonding Systems	4-10
I.	Painting Galvanic Cells	4-11
J.	Crevice Corrosion	4-12
K.	Inspection of Fastenings	4-12

L.	Inspection of Caulking	4-13
M.	Inspection of Fittings	4-14
N.	Hull Damage	4-15
O.	Deficiencies	4-15

CHAPTER 5. REPAIRS

A.	General	5-1
B.	Planking Repair and Notes on Joints in Fore and Aft Planking	5-1
C.	Diagonal Planking	5-2
D.	Plywood Repairs	5-2
E.	Butt Joints in Planking	5-3
F.	Mechanically Fastened Scarfs	5-4
G.	Framing Repairs	5-6
H.	Decayed Frame Heads	5-7
I.	Treating Isolated Decay	5-7
J.	Sheathing of Existing Wood Hulls	5-8

ANNEXES

Typical Construction Details	C-1
References	R-1

ACKNOWLEDGMENTS

This Navigation and Vessel Inspection Circular is the result of a joint effort between the Wooden Boat Industry and the Coast Guard to provide the latest and most practical methods of wooden boat inspection and repair. Every effort was made to harness the collective expertise and practical insight of Coast Guard field inspectors and wooden boat builders, shipyard repairers, marine surveyors, and operators.

Special thanks goes to the following people who comprised the Joint Industry/Coast Guard Wooden Boat Inspection Working Group and actively participated in the revision of NVIC 1-63:

Mr. Giffy Full, Surveyor, Brooklin, Maine
Mr. Edward McClave, Consultant, Noank, Connecticut
Mr. Fred Hecklinger, Surveyor, Annapolis, Maryland
Mr. K. T. Smith, Builder/Repairer, Yorktown, Virginia
Mr. Bill Holland, Builder, D'Iberville, Mississippi
Mr. Meade Gougeon, WEST SYSTEM Developer, Bay City, Michigan
Mr. Ernie Baird, Repairer, Port Townsend, Washington
Captain Kenneth Franke, USCG (Retired), Surveyor, San Diego, CA
Commander Al Moore, USCG (Commandant G-MI/T)
Commander Bill Uberti, USCG (Commandant G-MVI-1)
Lieutenant Commander Marc Cruder, USCG (Commandant G-MVI-2)

This NVIC reflects the wooden boat building and repair methods acceptable at the time of its publishing. It is not meant to be the sole authority on this subject. Survey and repair methods not discussed in this NVIC which have proven themselves "seaworthy" should be forwarded to the Coast Guard (Commandant G-MCO-2) for consideration in any future revision.

LIST OF FIGURES AND TABLES

Figure A	Typical Wood Screw	3-5
Figure B	Wood Screw Properly Inserted and Countersunk	3-5
Figure C	Stray Current Corrosion	4-9
Figure D	Bonding Systems	4-10
Table 4-1	The Galvanic Series of Metals in Seawater	4-17
	Notes on the Use of the Galvanic Series Table	4-18
Figure E	Common Forms of Scarfs	5-5

GLOSSARY

of common wooden boat design/construction words
(see Annex C for illustrations of typical construction details)

Ashcroft Construction - Double diagonal planking system with the planks of both skins raking in the same direction.

Backbone - The "spine" of the hull from which the frames radiate.

Back Rabbett - The surface against which the side of a plank lies in a rabbetted member. The end fastenings of the plank penetrate the back rabbett of a stem or sternpost; the lower or inner edge fastenings of a plank penetrate the back rabbett of a keel or horn timber. See diagram below.

Rabbett line = Outer Rabbett Line
Apex Line = Middle Rabbett Line, Margin Line
Bearding Line = Back Rabbett Line, Inner Rabbett Line

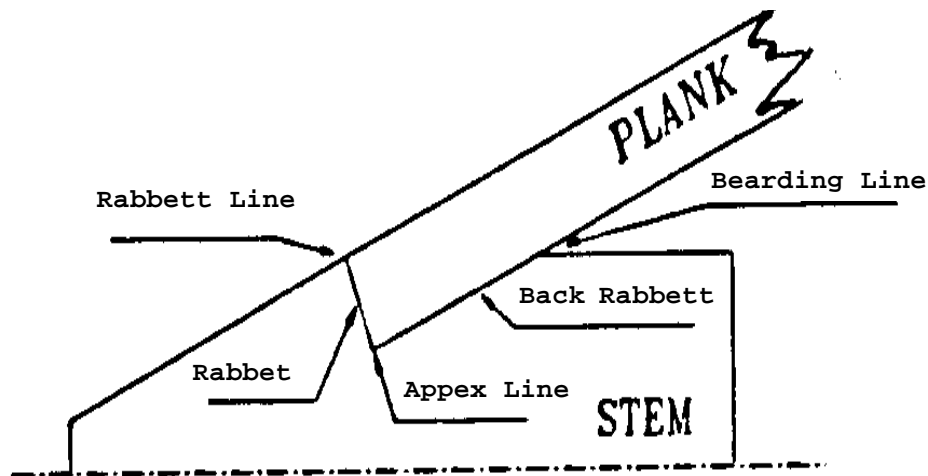

Ballast - Added weight either within or external to the hull added to improve the stability of a vessel or bring it down to its designed lines.

Balsa Sandwich - End grain balsa wood used as a core between FRP laminates.

Bastard Sawn - Hardwood lumber in which the annual rings make angles of 30 degrees to 60 degrees with the surface of the piece.

Batten - A thin flexible piece of wood.

Beam - A structural member supporting a load applied transversely to it. The transverse members of a deck framing system; the width of a vessel.

Beam Knee - A gusset like member used to connect a beam to a frame.

Bearding Line - The line formed by the intersection of the inside of the planking with the side or face of the keel.

Bending Steam - The process of forming a curved wood member by steaming or boiling the wood and bending it to a form.

Bilge Plank - A strengthening plank laid inside or outside of a vessel at the bilge's turn; also known as "Bilge Stringer".

Binding Strake - An extra thick strake of side or deck planking.

Box Section Mast - A hollow mast of round, square or rectangular section made up of long strips of wood.

Breasthook - Timber knees placed horizontally between two fore ends of stringers to reinforce their connection to the stem.

Butt Block - A short longitudinal piece of wood used to back up the connection of two plank ends.

Buttock - That part of a vessel's stern above her waterline which overhangs or lies abreast of the stern post; the counter.

Buttock Lines - Lines representing fore and aft vertical sections from the centerline outward.

Camber - The curve of a deck athwartships.

Cant Frames - Frames whose plane of support is not perpendicular to the fore and aft line.

Capping - Fore and aft finished piece along the topside of an open boat, often improperly termed gunwale; called a covering board, margin plank or plank sheer in a decked vessel.

Carlin - The fore and aft members of the deck framing system.

Carvel Planked - Smooth skinned planking whose strakes run fore and aft.

Caulking (calking) - Cotton, oakum or other fiber driven into planking seams to make them watertight.

Ceiling - An inner skin of the hull often used to add strength in boats having sawn frames. In some cases the ceiling is not structural but merely serves to line the hull for decorative purposes or for ease in cleaning.

Chain Plate - (Shroud Plate) A flat strip of metal fastened through the hull, either from inside or outside, to which the lower ends of the shrouds are attached.

Check - A lengthwise separation of the wood that usually extends across the rings of annual growth and commonly results from stresses set up in wood during seasoning.

Chine - The line of intersection of the bottom with the side of a vee or flat bottomed vessel.

Clamp - The fore and aft member at the sheer line of the vessel to which the deck beams usually fasten.

Clench Planking - Lapstrake, in which the adjacent planks overlap like clapboards of a house.

Clench Fastening - Securing a nail or rivet by placing a rove (washer) over the inboard side and then bending the fastening over it. In many cases they are simply bent over by driving them against a backing iron, causing them to reenter the frame.

Clinker Built - See clench planking.

Coat, Mast - A protective piece, usually canvas, covering the mast wedges where the mast enters the deck.

Cold Bent (frames) - Frames which are bent on forms and after shaping are fitted to the vessel.

Cold Molded - A method of boat construction using a male mold over which layers of thin wood and/or plywood are diagonally laid and glued together. Can be covered with epoxy or FRP.

Cove Line - A hollowed out decorative line found along the sheer of a boat.

Covering Board - A plank used as a "washboard" or "plank sheer" along the outer edge of the deck. - See Capping.

Cutwater - The forward edge of the stem at the waterline.

Dead Rise - The amount the bottom rises from keel to chine - most properly applied to " Vee" bottom construction but also used in reference to the rising bottom of round bottom boats.

Deadeye - A stout disk of hard wood, strapped with rope or iron, through which holes (usually three) are pierced for the reception of lanyards. They are used as blocks to connect shrouds and chain plates.

Deadwood - The vertical structure built up from the keel to support the cant frames at the stern or stem; longitudinal timbers of a vessel's structural backbone which lie entirely outside the keel, sternpost, and horn timber rabbet lines.

Decay - The decomposition of wood substance by fungi.

1. (Advanced or typical) - The older stage of decay in which the destruction is readily recognized because the wood has become punky, soft and spongy, stringy, ringshaked, pitted or crumbly. Decisive discoloration or bleaching of the rotted wood is often apparent.
2. (Incipient) - The early stage of decay that has not proceeded far enough to soften or otherwise perceptibly impair the hardness of the wood. It is usually accompanied by a slight discoloration or bleaching of the wood.

Deck Head - The underside of the deck.

Diagonal Planking - Planking laid on an angle to the keel.

Displacement - The actual weight of a boat as it "displaces" its weight when afloat; not to be confused with admeasurement tonnages.

Drift (Pins, Bolts) A long fastening driven (pin) or threaded (bolt) to receive end nuts, used for joining heavy timbers such as horn timbers and stern frames; also used to fasten and reinforce wooden panels on edge, such as rudders and centerboard trunks.

Dry Rot - A term loosely applied to any dry, crumbly rot but especially to that which, when in an advanced stage, permits the wood to be crushed easily to a dry powder. The term is actually a misnomer for any decay, since all fungi require over 20% moisture to grow.

Dutchman - Wooden block or wedge used to fill the void in a badly made butt or joint; a graving piece or repairing patch in a deck; filler; shim; short plank.

Edge-Grained Lumber - Lumber that has been sawed so that the wide surfaces extend approximately at right angles to the annual growth rings. Lumber is considered edged grained when the rings form an angle of 45 degrees to 90 degrees with the wide surface of the piece.

Edging - Amount required to be cut away from the edge of a plank in fitting strakes.

Edge Nailed - A method of fastening a strip plank to adjacent planks.

Facing - Building one piece of timber on another for strength or finish purposes.

False Keel - Sacrificial batten added to the keel to protect the keel from grounding and from marine borers; eg. worm shoe.

Faying - Joining closely together.

Flat-Grained Lumber - Lumber that has been sawed in a plane approximately perpendicular to a radius of the log. Lumber is considered flat grained when the annual growth rings make an angle of less than 45 degrees with the surface of the piece.

Floor or Floor Timber - A transverse structural member lying across the keel and tying the frames on either side of the keel together. The central futtock or futtocks of a sawn frame, lying across the keel. Floor timbers join both sides of a vessel together and make up the substructure for external keel fastenings, engine beds, and mast steps.

Floorboards - Planking laid on top of the floors to provide a walkway. Also known as the "sole."

Frame - The transverse structure at each section giving form to the hull. Frames connect to the keel or keels on and to the clamp or shelf at the sheer. Also known as "ribs."

Freeing Port - Any direct opening through the vessel's bulwark or hull to quickly drain overboard water that has been shipped on exposed decks.

Futtock - Curved parts or sections of transverse frames extending from the floor timbers to the top timbers.

Garboard - The strake of planking nearest the keel.

Green - Freshly sawed lumber, or lumber that has received no intentional drying; unseasoned. The term does not apply to lumber that may have become completely wet through waterlogging.

Grub Beam - A built up beam of short heavy timbers used to shape a round stern.

Gusset - Any piece that is used to join or strengthen the joint of two other pieces.

Hanging Knee - A strengthening bracket used between frames and deck beams.

Heartwood - The wood extending from the pith to the sapwood, the cells of which no longer participate in the life processes of the tree. Heartwood may be infiltrated with gums, resins, and other materials that usually make it darker and more decay resistant than sapwood.

Horn Timber - One or more timbers forming the main support for an overhanging stern and extending aft from the upper end of the stern post. Also used for timber connecting the shaft log and body post with the rudder post.

Horse (n) - The form upon which a small boat is built.

Horse (v) - To drive home, as to horse caulking.

Hot Frame - A frame which, after being softened by heat, is bent into shape as it is installed.

Joint - The junction of two pieces of wood or veneer.

Butt Joint - An end joint formed by abutting the squared ends of two pieces. Because of the inadequacy in strength of butt joints when glued, they are not generally used.

Edge Joint - The place where two pieces of wood are joined together edge to edge, commonly by gluing. The joints may be made by gluing two squared edges as in a plain edge joint or by using machined joints of various kinds, such as tongue-and-grooved joints.

Scarf Joint - An end joint formed by joining with glue and mechanical fastenings the ends of two pieces that have been tapered or beveled to form a sloping plane surface, to the same length in both pieces. In some cases, a step or hook may be machined into the scarf to facilitate alignment of the two ends, in which case, the plane is discontinuous and the joint is known as a stepped or hooked scarf joint or scarf joint with nib.

End Joint - The place where two pieces of wood are joined together end to end, commonly by scarfing and gluing.

Lap Joint - A joint made by placing one piece partly over another and bonding the overlapped portions.

Starved Joint - A glued joint that is poorly bonded because insufficient quantity of glue remained in the joint. Starved joints are caused by the use of excessive pressure or insufficient viscosity of the glue, or a combination of these, which result in the glue being forced out from between the surfaces to be joined. This term should only apply to epoxy glues. Joints made with other waterproof or water resistant glues like resorcinol and urea-formaldehyde (brown glue) should be starved for maximum strength.

Keelson - An inner keel usually laid over the floors and through bolted to the keel.

Kerf, Kerfing - To cut or make a channel with a saw blade.

Kiln Dried - As in timber, refers to forced hot air circulation through a chamber to dry the wood.

King Plank - The centerline plank of a deck.

Knee - See Hanging Knee.

Knot - That portion of a branch or limb which has been surrounded by subsequent growth of the wood of the trunk or other portion of the tree. As a knot appears on the sawed surface, it is merely a section of the entire knot, its shape depending upon the direction of the cut.

Lapstrake - See Clench Planking.

Limber - A hole allowing the free passage of water from one area to another.

Lignum Vitae - A hardwood used for deadeyes and propeller shaft bearings.

Making Iron - A large caulking iron used to drive oakum into plank seams.

Mast Partners - Carlins between deck beams to strengthen the area where the mast passes through the deck.

Molding - Measurement of a plank or timber from inboard to outboard, i.e., parallel to the plane in which the member lies; opposed to siding measured at right angles to such plane. Thus, the molding of a frame is measured in the thwartship direction while that of a stern piece is its cross sectional dimension fore and aft.

Nib - The squared off end of a tapered piece such as a scarf.

Noble Metal - A metal most resistant to deterioration due to galvanic action; the cathodic material.

Oakum - A caulking material of tarred fibers.

Partner - Stiffening or supporting pieces fitted in way of the passage of a mast through a deck. See Mast Partners.

Paying - The filling of the seam with seam putty, pitch, tar, or other type of seam sealant after caulking it.

Pitch Pocket - An opening extending parallel to the annual growth rings containing, or that has contained, pitch, either solid or liquid.

Plank - Strips of wood that form the "skin" of a boat; strakes.

Plank Sheer - See Capping.

Preservative - Any substance that for a reasonable length of time is effective in preventing the development and action of wood-rotting fungi; borers of various kinds and harmful insects that deteriorate wood.

Prick Post - An outer post supporting an outboard rudder.

Quarter Knees - Lateral brackets similar to the breast hook used to join the sheer shelf or clamps to the transom.

Quartersawed Lumber - Another term for Edge-Grained Lumber.

Rabbet - A longitudinal channel or groove in a member which received another piece to make a joint.

Racking - Two or more structural members working and becoming loose; structural deformation of the transverse section of a ship's hull. A vessel is said to be racked if, when viewed end on, it appears to be leaning or tilting over to one side. Symptoms of racking generally appear at the junction of the frames with the beams and floors.

Resorcinol - A formaldehyde resin to which a powder hardener is added to form a strong water resistant wood glue.

Rib - See Frame.

Sampson Post - Any post well attached to the vessels structure to take excessive loads; used as a bitt.

Scantling - The dimensions of all structural parts used in building a boat. A full scantling vessel is of maximum required structural dimensions.

Scarf (scarph) (n) - A joint by which the ends of two structural pieces of timber are united so as to form a continuous piece; a lapped joint made by beveling off, notching or otherwise cutting away the sides of two timbers at ends, and bolting, riveting, or strapping them together so as to form one continuous piece without increase in sectional area at the joint.

Scarf (v) - To join the ends of two timbers so as to form a continuous piece in appearance; the joining of wood by sloping off the edges and maintaining the same cross section throughout the joint.

Scupper - A pipe or tube leading down from a deck and through the hull to drain water overboard.

Shake - A separation along the grain, the greater part of which occurs between the rings of annual growth.

Sheer, Sheer Line - The intersection of the deck and the hull; the longitudinal sweep of the deckline from the stem to the sternpost upward at the ends in traditional designs, and downwards at the ends in reverse-sheer designs.

Sheer Strake - The top or uppermost plank in a hull.

Shelf - Line of timbers bridging and thus stiffening frames but chiefly for supporting the end of the deck beams.

Shipworm - A misnomer for the wood boring mollusk *Teredo* which feeds on wood cellulose. Another but different marine borer, the *Limnoriae*, is also misnamed shipworm.

Siding - Generally the sawn or planed thickness of the planks or timbers from which wood members are shaped or cut. See Molding.

Sister - As in sister frame or sister keelson. A member attached to or laid alongside an original member to strengthen it, either as an original construction technique or as a repair.

Spiling - The edge curve in a strake of planking.

Split - A separation of the wood with the grain due to the tearing apart of the wood cells.

Spline - As in spline planking. A thin tapered strip of wood glued and hammered into carvel plank seams which have become enlarged and spill caulking internally.

Stain - A discoloration in wood that may be caused by such diverse agencies as micro-organisms, metal, or chemicals. The term also applies to materials used to impart color in wood.

Stealer - In the shell planking toward the ends of a vessel a strake introduced as a single continuation of two tapering strakes. One of (usually the shorter or narrower of) the two planks which are butted into a single plank as double continuation or as the short piece notched into a larger plank to add width not available on one board.

Stern Frame - The frame work around the inside of the transom.

Stopwater - A softwood dowel driven across a lap, scarf, or butt joint in the backbone structure or elsewhere, to prevent seepage of water into the hull; any contrivance to accomplish this purpose.

Strake - One of the rows or strips of planking constituting the surface of the hull.

Strip Planking - Carvel construction where each plank is edge nailed to the adjacent planks.

Taffrail - A timber rail around the aft deck of a vessel.

Treenail - (Trunnel) A wood dowel used as a fastening; often fitted with a wedge in the dowel end to hold it in place. Dense wood such as locust is used for the dowel.

Wane - A defective edge or corner of a board caused by remaining bark or a beveled end.

Warp - Any variation from a true or plane surface. Warp includes bow, crook, cup and twist or any combination thereof.

Weathering - The mechanical or chemical disintegration and discoloration of the surface of wood caused by exposure to light, action of dust and sand carried by winds and alternate shrinking and swelling of the surface fibers with the variation in moisture content brought by changes in the weather. Weathering does not include decay.

Welt - A strip of wood fastened over a flush joint or seam for strengthening purposes; a seam batten.

Wicking - A caulking material such as oakum or cotton, used to wrap a fastening in order to protect it from moisture.

Worm Shoe - A non-structural piece of wood placed at the bottom of the keel to protect the keel from marine borers.

CHAPTER 1: DESIGN CONSIDERATIONS

A. INTRODUCTION

Watercraft have evolved over centuries of trial and error to the more "modern" state of the art vessels we are now familiar with. Wood as a boat building material is still used in many parts of the world as the most readily available, easy to work, repairable material for marine applications. Even with the advent of composites, fiber reinforced plastic (FRP) and lightweight metals, wood will for many years to come, continue to be a major factor in the design of boats.

B. ACCEPTABLE CLASSIFICATION SOCIETY RULES

Lloyds Register of Shipping Rules and Regulations for the Classification of Yachts and Small Craft is the standard adopted by reference in Coast Guard regulations for the design and construction of wooden small passenger vessels. Lloyds Rules apply to vessels of up to 50 meters (164 feet scantling length).

Other classification society standards may be accepted on a case-by-case basis.

C. GOOD MARINE PRACTICE

No single publication contains all the innovations found in the design of wooden vessels. This circular and the readings referenced in Annex R form a basis of good marine practices from which owners, designers, builders, inspectors and surveyors can, along with experience, maintain the highest level of small passenger vessel safety.

D. TYPICAL CONSTRUCTION DETAILS

Annex C contains several illustrations of typical construction details. An index of these illustrations can be found on page C-1.

CHAPTER 2: PLAN SUBMITTAL GUIDE

A. INTRODUCTION

This chapter is intended as a general reference and guide for submitting the plans for a proposed vessel to the Coast Guard. It is not a complete text on naval architecture or a commentary on classification society rules. Plans should be submitted in accordance with the appropriate regulations to the Marine Safety Center (MSC) in triplicate.

B. PLAN REVIEW

1. Plans for small passenger vessels of wooden construction are generally reviewed by the local Officer in Charge, Marine Inspection (OCMI). For vessels over 65 feet in length and/or vessels incorporating novel designs or specifications not entirely addressed by acceptable Classification Society Rules, plan review will be conducted by the (MSC).
2. Lloyd's Rules and Regulations for the Classification of Yachts and Small Craft should be used as a reference for designs as well as application to existing vessels.

C. OTHER CLASSIFICATION SOCIETY RULES AND STANDARDS.

1. Direct reference to Lloyd's Rules is based on the familiarity that Coast Guard inspectors and technical personnel have with reviewing a vessel designed to those standards. This does not prevent a design from being based on the rules of another classification society or on some other standard. The burden of proof rests with the designer to show, with thorough engineering documentation and logic, that a proposed vessel meets a level of safety at least equivalent to that prescribed by Lloyd's Rules.
2. Another useful "historical" reference that may be used as a plan review guide is "Merchant Marine Safety Instruction 14-60" dated 14 April 1960. This instruction contains scantling tables for 500 wooden T-Boats up to 60 feet in length, which have been approved for routes ranging from rivers to oceans. The scantlings in this reference are from a sampling of vessels certificated based on years of satisfactory service similar to the present "Five Year Rule" noted below.

D. THE FIVE YEAR RULE

1. Definition. The "Five Year Rule" is defined as:

"When scantlings differ from such standards and it can be demonstrated that craft approximating the same size, power and displacement, have been built to such scantlings and have been in satisfactory service insofar as structural adequacy is concerned for a period of at least 5 years, such scantlings may be approved. A detailed structural analysis may be required for specialized types or integral parts thereof." Determinations for meeting this rule are made for each case on individual basis by the OCMI.

2. Burden Of Proof . The burden is upon the designer or owner to show the similarities between the proposed vessel and an existing vessel. The Coast Guard approving authority may need documentation showing the similarities in size, power, displacement and scantlings, and may conduct a survey and/or underway check of the similar vessel's performance in the anticipated operating area. Scantlings can vary greatly for similar sized wooden vessels depending on materials used.

3. Satisfactory Service . The service life of small passenger vessels vary greatly depending on location, maintenance, and use. An inner harbor tour boat experiences a vastly different service environment than does a deep sea party fishing vessel, and is normally designed quite differently. An existing vessel used as a basis for a proposed new vessel should have experienced at least the same operating environment planned for the new vessel for five years, showing satisfactory service. A similar relationship of experienced service to expected service should be presented to the OCMI for an existing vessel changing service into Coast Guard certification.

CHAPTER 3: MATERIAL

A. SHIPBUILDING WOOD

Wood is an engineering material. Douglas Fir, Southern Yellow Pine (long leaf), and White Oak furnish most of the wood used for boat and shipbuilding in the United States. Of these, Douglas Fir is the predominant choice due to availability and relatively rapid growth.

1. When requirements call for strength, moderate to good decay resistance and ability to hold fastenings well (frames, keels, stems, etc.), the following woods are most commonly used:

Douglas Fir
Southern Yellow Pine (long leaf)
Teak
Western Larch
White Oak

2. Where light wood, which is easy to work and is warp and decay resistant, is required (planking, etc.) the following woods are most commonly used:

Cypress
Mahogany
Cedar (Port Orford, Northern White, Western Red and Alaska)
Tangile (Philippine hardwood)

3. Where light, easily worked and strong woods of moderate to low decay resistance are required, the following woods have found favor:

Sitka Spruce
Western Hemlock
White Pine
Yellow Poplar

There are many other varieties suitable for boat use. These are listed together with their properties in The Encyclopedia of Wood and Wood - A Manual for its use as a Shipbuilding Material (References 1 and 10).

B. BENDING WOODS

Unseasoned White Oak is the choice bending wood. It bends readily and is high in decay resistance. Red Oak, Hickory, Rock Elm, White Ash, Beech, Birch, and hard Maple, also bend readily but do not have the decay resistance of White Oak. White Oak and its best substitute, Rock Elm, are expensive and hard to obtain, but do the best job. For a further discussion of the effects of bending and bending ratios of various types of woods see "Bent Frames", Wooden Boat, No. 86, page 87.

It is important to remember that bending woods are unseasoned and therefore should show a moisture content over 15% (18% is desirable). Attempting bends with dry wood results in cracks across the grain particularly in hulls with sharp bends at the turn of the bilge.

C. PLYWOOD

Plywood is a built up board of laminated veneers in which the grain of each "ply" is perpendicular to the ones adjacent to it. Its chief advantages lie in more nearly equal strength properties along the length and width of the panel, resistance to change in dimensions with moisture content and resistance to splitting. Major disadvantages are low decay resistance and the difficulty of painting it properly.

Plywood is excellent where strength is needed in more than one direction and where the relatively large size of the panels available can be utilized. It is no stronger than the wood from which it is made and is not a cure-all for wood structural problems.

Plywood is made from several types of wood and in many different types and grades. In general, "Marine-Exterior" type of fir plywood or its equivalent, technical or Type 1 hardwoods are the only plywoods acceptable for use as hull planking. These plywoods are identical with ordinary "Exterior" type in that they are bonded with waterproof glue by a process using heat and pressure. Their advantage lies in the fact that the interior plies contain few gaps and thus its strength, ability to hold fastenings and resistance to decay are much higher than "Exterior". "Marine" plywood is more expensive than "Exterior" but provides additional safety and durability.

Fir plywood is graded according to the appearance of the exterior veneers. These grades run from grade "N" intended for natural finish and grade "A", suitable for painting, down through grade "D", the poorest quality. Each side is graded. For example, a panel may be graded "Marine Exterior A-B" where "Marine Exterior" refers to the type of bonding used and the allowable defects in the inner plies, while "A-B" refers to the appearance of the two sides of the panel.

Marine plywood is usually available only in appearance grades B-C and better. The strength of the wood is indirectly reflected in the grading since the poorer grades have openings, splits, pitch pockets and other defects which adversely affect strength and decay resistance.

All plywood is marked with its classification. This classification may appear on the panel back, on its edge or both. Marine plywood is clearly marked "Marine".

D. WOOD DEFECTS

Wood, being a natural material, is not uniform in quality and is subject to defects. Some of these affect only the appearance of the wood. Others affect the strength of the wood and are of importance.

Boat building and repair craftsmen carefully select each piece for the intended use. Often a load of timber, even milled from the same tree, will display a variety of defects. Wood with knots, checks, excessive warp, splits and pitch pockets should be rejected for use particularly in hull structure applications.

E. MECHANICAL FASTENINGS; MATERIALS

Mechanical fastenings should be of material suitable for the service intended. Ferrous fastenings should be hot-dipped galvanized. Among the usual non-ferrous types brass is not acceptable in salt water applications as it will corrode from de-zincification and is inherently soft and weak.

Caution should be used in selecting fastening material because of the problem of galvanic action which can arise if dissimilar metals are used close to one another. A bronze washer used with a steel bolt will result in the eating away of the steel. Proper selection of fastening materials will significantly prevent corrosion and thereby extend their service life.

Marine applications of stainless steel alloys (chromium-nickel) are subject to a phenomenon known as contact corrosion or more commonly, crevice corrosion. Stainless steels which are in contact with each other or placed in tight joints (nuts and bolts), swage connections (standing rigging), or used to fasten wood planking below the waterline, corrode at an alarming rate. The vehicle of crevice corrosion is electrolytic cell formation. If the stainless steel is unable to naturally form a thin film of chromium oxide to shield the material from attack, corrosive liquids such as salt water are able to establish electrolytic cells with chloride ions and corrosion takes place. In short, stainless steel depends on oxygen to provide protection against crevice corrosion.

Grade 316 L (passive) stainless steel is the most accepted material for marine applications due to the introduction of molybdenum to the alloy. For example: grade 304 stainless steel has 18% chromium and 8% nickel in the alloy while grade 316 L has 18% chromium and 10% nickel and 3% molybdenum. Grade 304 is quite susceptible to crevice corrosion when employed in tight spaces and unable to generate chromium oxide. The 316 L material will last longer in the same application.

Chandlers usually stock only brass and stainless steel, both being very unsuitable for underwater fastenings. The grade of stainless is rarely mentioned and is often only Type 304.

Generally, stainless steel fasteners should not be used underwater. However, they are used quite frequently, but only if all of the following conditions are met will they be satisfactory:

- (a) Austenitic grade at least Type 304, preferably Type 316.
- (b) Not passing through wet wood.
- (c) Ample sealant under the head and in between mating surfaces.
- (d) The item to be fastened is less noble than stainless; i.e. all the copper alloys and, with some risk of hole enlargement, steel and iron.

Note: Condition (b) indicates that stainless wood screws should never be used underwater.

The choice of stainless steel fasteners below the waterline should be carefully considered based on the water salinity, grade of stainless steel fastener available, and material of other fasteners and fittings in the hull. Stainless steel may be subject to varying degrees of accelerated crevice corrosion. For more information, see Metal Corrosion in Boats, (Reference 13).

The number, size, type and spacing of fastenings for various applications are given in Lloyd's Rules and Regulations for the Classification of Yachts and Small Craft, Part 2, Chapter 4.

A general guide for use of the various types of fastenings follows:

F. SCREW FASTENINGS

1. Lead Holes. Lead holes for wood screws should be about 90% of the root diameter of the screw for hardwoods and about 70% of the root diameter for softwoods. For large screws and for hardwoods, a shank hole of a diameter equal to the shank of the screw and of a depth equal to the shank may be used to facilitate driving. Lag screws should always have a shank hole.

The lead hole for the threaded portion of a lag screw should have a diameter of 65-85% of the shank diameter in oak and 60-75% in Douglas Fir and Southern Pine with a length equal to the length of the threaded portion. Denser woods require larger lead holes and the less dense require smaller holes. For long screws or for screws of large diameter, lead holes slightly larger than those recommended here should be used. The threaded portion of the screw should be inserted by turning and not by driving with a hammer.

Where possible, screws should be selected so that the unthreaded shank penetrates the joint for greatest strength and corrosion resistance, and to facilitate the drawing together of the members. In this case, the shank hole shall extend the full length of the shank. If conditions prevent the shank from extending through the joint, the shank hole shall extend completely through the member containing the head, to prevent threads from engaging in that member, which might prevent the joint from drawing up.

Figure A: Typical Wood Screw

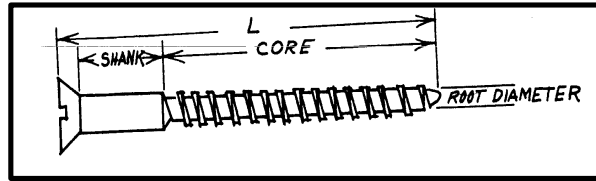
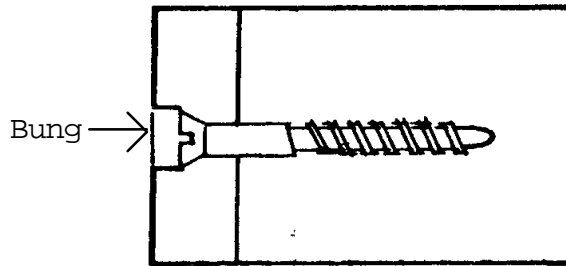

Figure B: Wood Screw Properly Inserted And Countersunk



2. Lubricants. Suitable lubricants such as wax, grease, or heavy paint, but never soap should be used on screws, especially in dense wood, to make insertion easier and prevent damage to the screw.
3. Depth. Penetration of the threaded portion for at least a distance of 7 screw diameters for hardwoods and 10-12 in softwoods is required for maximum holding power.
4. Loading. If possible, screws should be placed so that they are loaded across the screw and not in the direction of withdrawal.

The spacing, end distance and edge distances for wood screws should be such as to prevent splitting the wood. Lag screws should follow the rules for bolts. For further information concerning wood screws, see Wooden Boat, Issue 54 & 55 (Reference 17).

G. NAIL FASTENINGS

Hot dipped galvanized cut boat nails have traditionally and are still being used in boat building. Barbed or annular ring nails have been successful and are suitable depending upon their application (usually smaller scantling vessels). Smooth, thinly coated or plated nails, with small irregular heads and long tapered shanks such as horseshoe nails and ordinary "cut nails" (i.e. hardwood flooring nails) will not provide sufficient holding power and should not be used. In addition, wire nails are not acceptable for hull construction.

1. Lead Holes. Lead holes for nailed joints may be 3/4 of the diameter of the nail without causing loss of strength.
2. Types Of Load. If possible, nails should be loaded across the nail and not in the direction of withdrawal. This is especially important in end grain.
3. Spacing Of Nails. The end and edge distances and spacings of the nails should be such as to prevent splitting of the wood.

H. BOAT SPIKES AND DRIFT BOLTS

1. Lead Holes. Lead holes for boat spikes should be the size of the short dimension of the spike and should extend approximately 75% of the spike depth. The lead holes for drift bolts should be slightly less than the bolt diameter and of a depth equal to the bolt length.
2. Type Of Load. Where possible, spikes and drift bolts should not be loaded in withdrawal. This is especially important in end grain.
3. Insertion. A clinch ring or washer may be used under the head to prevent crushing of the wood. Spikes should be driven with the edge of the chisel point across the grain to avoid splitting the wood.
4. Spacing of Spikes and Drift Bolts. The end distance, edge distance and spacing of the spikes should be such as to avoid splitting the wood.
5. Bolts. Bolt holes should be of such diameter as to provide an easy fit without excessive clearance. A tight fit requiring forcible driving of the bolt is not recommended.
6. Placement Of Bolts In Joint. The center to center distance between bolts in a row should be not less than four times the bolt diameter.

The spacing between rows of bolts should be 5 times the bolt diameter for a bolt whose length from the bottom of the head to the inner side of the nut when tightened is 6 times the bolt diameter or longer. For short bolts, this distance may be decreased but in no case should be less than 3 times the bolt diameter.

The "end distance" from the end of a bolted timber to the center of the bolt hole nearest the end should be at least 7 times the bolt diameter for softwoods and at least 5 times the bolt diameter for hardwoods. These requirements should be relaxed where necessary in the case of bolted planking butts to allow the "front row" of fastenings on each side of the butt to be bolts.

The "edge distance" from the edge of the member to the center of the nearest bolt hole should be at least 1 1/2 times the bolt diameter. For bolts whose length is over six times their diameter, use one half the distance between bolt rows and in no case below 1 1/2 times the bolt diameter.

For perpendicular to the grain loadings (joints at right angles), the edge distance toward which the load act, should be at least 4 times the bolt diameter.

I. BOLTING GROUPS

In general, all groups of bolts should be symmetrical in the members. The individual fastenings should be offset slightly as necessary to avoid placing more than one on the same grain.

1. Washers. The importance of washers, especially under the heads of fastenings which may be loaded in tension either because of external stresses or because of swelling stresses, cannot be overstated. The weak link in most metal-fastened wood structures is not the tensile strength of the wood or of the fastenings, nor the withdrawal resistance of threaded fastenings. The weak link is almost always the cross-grain crushing strength of the wood under the heads of the fastenings. Care should be exercised in drawing nuts down on the bolts too tight and crushing the wood.
2. Wickings. A suitable wicking should be fitted in way of the faying surface of the joint at each through bolt subject to moisture.

J. ADHESIVES

Household glues having low moisture resistance have tendencies towards early joint failure and should be avoided in marine applications.

Resorcinol and Phenol-Resorcinol resin type marine glues have been used for many years and are satisfactory for most new construction and repair applications. Resorcinol age hardens and becomes brittle and inelastic over time and should be limited to rigid surfaces where shear, vibration and impact forces are unlikely.

Urea-type adhesives such as Weldwood Plastic Resin glue are available in water mix one-part and two-part resin/hardener mixes. Use of ureas requires special care particularly with the two part system as, unlike epoxy resins, the urea is applied with resin on one surface and the hardener on the other. Clamp pressure is then applied and the cure begins.

Epoxy resins are available for a wide variety of marine applications and have been found to provide excellent adhesion in all areas of boat building. In the early 1960's epoxy adhesives were introduced to western boat builders by the Gougeon Brothers of Bay City, Michigan, through their registered trademark WEST SYSTEM. Epoxy resins are two part adhesives and depend on accurate mixing ratios to yield high strength joints. Epoxy is also an excellent filler material when thickened to high or low density with micro fibers, micro balloons or colloidal silica.

Not all woods are easily joined. Wet wood (above 18% moisture content) is difficult to glue. Normal seasoned wood of most species can be glued. Strong joints can be made bonding either face or side grain of the wood. These joints can be very nearly as strong as the wood itself. It is impossible to join end grain with glue and get joints which are even 20% as strong as the wood. A scarf or some other form of joint which gives a surface approaching side grain condition must be used where end connection is desired.

As with any chemicals the manufacturer's instructions must be carefully followed. Curing temperature and surface condition are important. The temperature must be about 70 degrees Fahrenheit or higher for a full cure of resorcinol resin glue. Faying surfaces should be well fitted. Smooth surfaces make the strongest joints with resorcinol, however a roughened surface for epoxy joints is generally helpful in improving bond strength, especially with hardwoods, such as oak.

K. WOOD PRESERVATIVES

The use of wood preservatives is not required. However, their use in wood under severe service conditions may pay for itself many times in decreased decay and borer attack and thus decreased repair and replacement costs. Their proper use should be encouraged since it increases the chance of the vessel remaining sound until her next inspection and thus contributes to maintaining a reasonable standard of safety.

Wood preservatives used for protection against decay fungi and marine borers either kill the organism or prevent it from growing. For marine use the preservative must offer no toxic hazard to the crew, must be free from objectionable odors and must be able to remain in the wood and do its work in the presence of moisture. No known wood preservative is ideal for marine use but certain ones have proved effective for specific applications.

There are two general classes of wood preservatives, oil soluble and water soluble. Both have been used in the marine industry.

1. Oil Soluble Preservatives.

- A. *Coal Tar Creosote*. One of the most effective of the oil soluble preservatives is coal tar creosote. This preservative is highly toxic to wood attacking organisms, is relatively insoluble in water and is easy to apply. It has a distinctive unpleasant odor, is somewhat of a fire hazard when freshly applied and causes skin irritation in some individuals. Its main disadvantage is that it is a hazardous material to the environment and thus has become unavailable for boat building applications. However, some older vessels with deadwood, keel, stems and heavy timbers which were originally treated with creosote, are still in service

- B. *Copper Naphthanate Solutions.* Copper naphthanate solutions form one of the most used groups of marine wood preservatives. A three percent solution, equivalent to one half of one percent copper by weight, provides good protection against decay when properly applied. The protection afforded against marine borers is slight. Wood treated with copper naphthanate is a distinctive green color. Much of the "treated wood" which can be purchased is preserved with copper naphthanate. The paintability, glue bonding ability, and structural stability of the wood is only slightly affected by the copper salts. These properties will vary, however, depending upon the oil used as a solvent. It is important to note that this substance poses a serious health hazard to humans. Full body protection should be worn during application.
- C. *Pentachlorophenol Solutions.* "Penta" solutions have proven satisfactory for marine use. Field tests have shown that a 5% solution offers adequate protection against decay when proper application techniques are used. Little if any protection against marine borers is provided.

Pentachlorophenol does not give wood any distinctive color. In itself, it affects the characteristics of wood very little. The final effect of the preservation treatment on physical characteristics depends upon the petroleum solvent used. Pentachlorophenol solution remains effective for approximately 2-3 years before it begins to break down.

2. Water Soluble Preservatives .

- A. *Water Soluble Preservatives.* Copper naphthanate and "penta" are often combined with water repellents. These repellents aid in stabilizing the moisture content of the treated wood. This is a material aid in reducing the chance that decay growth conditions will occur. In order to be effective these solutions should contain no less than 5% pentachlorophenol or 2% copper in the form of copper naphthanate.
- B. *Solvents.* Almost any petroleum product from mineral spirit to used engine oil can be used as a vehicle for the preservative depending upon local conditions. In general, the heavier high viscosity residuum types offer the best retention. The choice of solvent is usually a compromise of effectiveness, paintability and initial cost.
- C. *Water Preservatives.* Waterborne preservatives include zinc chloride, tanalith, copper arsenite, chromated zinc arsenate and many others. Their major applications are those in which the leeching out of the preservative by moisture is not a problem. In general, these preservatives have not proven satisfactory for severe marine service. Some preserved wood obtained for repair use may have been pressure treated with one of these preservatives. It can give satisfactory service if care is taken to use it in a location where it is protected from the action of rain and sea water

3. Methods Of Treatment.

A. *Pressure Treatment*. In the commercial treating of wood a method utilizing high pressure is often used. This method requires expensive equipment and is seldom seen in a boat yard. Nonpressure treatments available to the boat yard are brushing, cold soaking, and various types of "hot and cold" bath processes.

B. *Brush Treatment*. The simplest way of applying a preservative solution is to brush it on. Every crack and check must be flooded with preservative if the treatment is to be effective. Small pieces such as butt blocks can be dipped into the preservative. Solutions of pentachlorophenol or copper naphthanate available commercially, have proved effective when used in this way.

"Penta" stock solutions are available in what is know as 1:5 and 1:10 strengths, (i.e. the solution must be diluted one part of solution to five or ten parts of solvent to achieve a "normal" wood preserving solution). These stock solutions are used without dilution for applications such as preserving cracks, holes resulting from old fastenings, and coating joints and hard to get spots. Care must be exercised since wood preservatives are toxic. When using the brush-on method the entire surface must be thoroughly coated.

C. *Soaking*. Cold soaking in copper naphthanate or "penta" solutions for periods of up to 48 hours provides much better retention of the preservative than does a brushing. An even better method consists of heating the wood in a hot preservative bath and then transferring it to a cold bath of preservative. The heating causes the air entrapped in the wood to expand. The sudden cooling sets up a vacuum which aids preservative penetration.

Preservative solutions or other chemicals which release copper ions into wood or into the bilgewater should be avoided in vessels containing ferrous fastenings. Copper ions are more stable than iron, and will spontaneously plate out on steel or on zinc coatings, replacing equal numbers of iron or zinc ions, which go into solution (replacement corrosion). While the amount of direct wastage of iron or zinc from this mechanism is likely to be minimal, the presence of copper-plated regions on the surface of the steel fittings cause them to become small, isolated galvanic cells. The further corrosion of the steel or galvanizing may be significantly increased by the presence of copper surface inclusions.

Copper naphthanate (Cuprinol), Chromated Copper Arsenate (CCA) and Ammoniacal Copper Arsenate (ACA) wood preservatives are one common source of copper ions in the wood or bilgewater. Another source is the addition of chemical treatments to bilgewater. A traditional solution to the problem of sour bilges due to generation of hydrogen sulfide gas by bacteria breaking down spilled diesel fuel is to dissolve copper chloride crystals in the bilgewater.

CHAPTER 4: GUIDE TO INSPECTION

A. GENERAL

Intelligent inspection of wooden vessel construction requires knowledge and judgment. Inspection is made to determine that the vessel is safe and has a reasonable chance of remaining so until the next scheduled inspection. A good basic knowledge of wood construction and the deficiencies to which it is susceptible is essential.

B. WHAT TO LOOK FOR

Problems in wooden vessels group themselves into three categories:

1. Time
 - a. Decay
 - b. Wood Borers
 - c. Corrosion

2. Stress
 - a. Cracks
 - b. Broken members
 - c. Failure of fastenings
 - d. Failure of caulking

3. Damage
 - a. Hull damage due to collision, grounding or to normal wear and tear

C. STRUCTURAL PROBLEMS

In wooden vessels structural problems develop in nearly new vessels as well as in older ones. Deterioration, especially that caused by decay and wood borers, can occur with surprising rapidity. Boats which have been free of such infestations can become infected with slight changes in service area or operation. Fastening problems in new wooden vessels can also develop as a result of several types of corrosion.

Poor selection of wood structural materials or lack of ventilation will often make themselves known in the first year of a vessel's service life. That the vessel was sound at its last inspection has less bearing on the present condition of a wooden vessel than on one of steel.

D. CONDITION OF VESSEL FOR INSPECTION

If practicable, inspect the vessel out of the water with the interior of the hull opened up as much as possible. The bilges and forepeak should be dry and reasonably clean. Excess tackle, tools and gear which might interfere with proper inspection should be cleared away. This is not always possible; however, hard to inspect (and thus hard to maintain) areas should not be missed.

Where the interior of the hull has closely fitted ceiling or paneling, sufficient access should be provided to allow examination of the interior at selected locations. This can be accomplished on lighter scantling vessels by cutting inspection openings in the ceiling which will also aid in providing ventilation to combat dry rot. On heavy timbered vessels, borings or core samples may be used to show the condition of hidden structures. Apparent soundness of the ceiling should not be taken as indicative of soundness beneath.

In some cases access for frame inspection may be made by removal of sheer/waterline and/or garboard planks for inspection from the outside. In any case, visual inspection must be accomplished to ascertain conditions under ceilings. Full ceiling vessels often lack ventilation between frames therefore making them a likely place where decay can be found.

Some vessels will be found with poured concrete, ballast ingots or other interferences which make internal bilge inspection and condition of floor frames/fastenings and keel bolts difficult to evaluate. Where it is possible to remove some of the material without damaging the hull or internal structural members, sufficient access should be made for examination. Careful documentation of conditions found must be accomplished to avoid unnecessary removal of internals.

The vessel's underwater body should not be filled, faired or painted before it is examined. Coatings cover a multitude of defects such as cracks, bleeding or loose fastenings, discolored wood due to rot, and borer attack.

E. VISUAL INSPECTION

An overall examination of the hull of a wooden vessel which has been in service can give the inspector an idea of the portions where deficiencies can be expected. Distorted planking, pulled butts, local damage, and unexplained wetness or weeping are tell tale indications.

Particular attention should be paid to the garboard area, stem, stern, transom, region under the covering boards, the wind and water area, and around hull fittings. It is impossible to list each area of trouble in each type of boat. In general, areas which are hard to maintain, have poor ventilation or are subject to heavy stresses display the most deficiencies.

F. INSPECTION FOR DECAY AND WOOD BORERS

Serious deterioration of a wooden hull goes on within the wood itself with little or no outward sign until it is well advanced. In order to spot decayed wood, which has not progressed to the point where the wood appears eroded and spongy, sounding with hammer can be of use.

Unsound wood will give a dead or dull sound. Heavy timbers whose interiors are rotted may give a distinctive drum-like tone where the sound is not that of good solid wood, the member is suspect. Often, the first indication of "wet rot" is a distinctive musty odor which permeates the interior spaces of a closed up vessel. Deteriorated wood will be spongy when probed and repairs generally require complete renewal of the affected wood.

1. Decay. Decay in wood is caused by various fungi which are living organisms whose growth depends upon suitable temperature (50 degrees to 90 degrees F), suitable food (wood), moisture, and oxygen. Wood that is dry will not rot nor will waterlogged wood. In order to provide a condition suitable for fungus growth, wood must be moist (from 20 to 80% moisture content). This condition is promoted by poor ventilation. A well designed vessel should have adequate ventilation of its enclosed spaces. Bilges, cabins, etc., of vessels in service should be opened periodically to allow a change of air. Good ventilation of interior structure in wooden hulls is one of the most effective measures in the prevention of decay.

It should be realized that decay progresses rapidly and that it is more economical to eliminate small decayed areas early than become involved in costly major replacements caused by neglected decay.

Moisture meters can be of use particularly in areas where FRP overlays or paint may hide deteriorated wood. Use of the moisture meter and/or hammer should be followed up with probing or boring to develop the extent of the defect. Core sampling can be used to determine depth of deterioration.

It is imperative that indiscriminate probing and boring be avoided. Holes made by a probe or drill on the exterior are potential entry ways for wood borers. In the hull interior they allow moisture penetration and thus aid in starting decay. Probing and boring should be done carefully and only where there is an indication from non-destructive testing that the material is unsound, not as a matter of routine.

Holes made by boring should be plugged with dowels or plugs which are glued in place, not merely driven into the wood. Plugs and dowels should preferably be treated with wood preservative to prevent future trouble. Areas which have been probed should be filled with a suitable compound. When covering boards or other obscuring construction is involved, it is often difficult to locate deteriorated members by probing. In such cases, when bolted or screwed fastenings are used, check for tightness of randomly selected fastenings. If the member is solid, the fastenings thus set up will take hold at the beginning of the turn. If serious decay is present the fastening will turn freely and fail to take a bite, indicating soft and spongy wood.

Decay is most often found in the following locations:

A. *Internally.*

1. All areas that are poorly ventilated, i.e. at the stem, transom, and along the sheer.
2. In the bilge especially at the turn and along the keel.
3. The lower courses of bulkhead planking.
4. Areas under refrigerators, freshwater tanks and valves and other areas where fresh water can accumulate.
5. In the area of butt blocks and longitudinal members where dirt and debris may have retained fresh water.
6. At the heads of frames caused by fresh water leakage through defective covering boards and from condensation.
7. Where the futtocks of sawn frames join and at the faying surfaces where the frames abutt the hull planking.
8. At the terminal ends of frames, floors, engine foundations, etc. where end grain is present.

B. *Externally*

1. In joints where fresh water has penetrated.
2. Around deck metallic fastenings and penetrations.
3. At covering board joints.
4. In mast fastening locations and within natural checks or compression cracks.
5. Under spar hoops, gaff jaws, mast partner deck penetrations, and any other areas where wood is covered with metal or leather chafing gear.

Under freezing temperature conditions wood structural members with a high moisture content, particularly in the bilge areas, may appear quite sound when, in fact, they may be in advanced stages of decay. Periodic examination of these areas should be conducted before freezing sets in or after, allowing sufficient time for thawing.

The other principal form of deterioration which goes on within the wood is wood borer attack.

2. Marine Borers. Marine borers are present to a varying degree in almost all the salt and brackish waters of the world. They attack practically every species of wood used in boat construction. There is no sure method of protection from their attack. The two principal methods are to physically keep the worm away from the wood (sheathing) and to make the wood unattractive to the worm (toxic substances and coatings). The main types of marine borers are listed in the following paragraphs.

A. *Mollusks.* (Often called shipworms) There are several species of *Teredo* and *Bankia* in this group. Though they vary in detail, their attack upon wood follows the same pattern.

They start their lives as tiny free swimmers. Upon finding a suitable home, even a tiny crack in a sheathed bottom, they attach themselves and quickly change form. As a pair of cutting shells develop on their heads they bury themselves in the wood and feed upon it. Their tails or "syphons" always remain at the entrance to their burrow but, as the worms grow, their heads eat channels in the wood. The entrance holes always remain small and hardly noticeable but the interior of the wood becomes honeycombed. When they are not crowded, some species of shipworm can grow to lengths exceeding four feet. One species, (*Teredo Navalis*) can burrow up to 3/4" per day.

B. *Martesia.* These are wood boring mollusks which resemble small clams, they enter the wood when they are small and do their damage within. They do not grow to the length of shipworms but, nevertheless, they can do considerable damage. Their main area is in the Gulf of Mexico.

When borer attack is just starting it is possible to burn the holes clean with a torch and then fill them with a suitable compound. If the attack is extensive, however, the only method acceptable is to replace the affected wood.

The first principle in reducing the chance of borer attack is to keep the worm away from the wood. This is accomplished by sheathing or by toxic paints. If the protective coating is broken borers can enter. To prevent this, sheathing where fitted, should be unbroken and in good condition and the bottom paint should be free from scratches, nicks and scrapes before the vessel is launched.

Wormshoes, rubbing strakes and similar members whose protective coatings have been broken should be inspected carefully. If they have heavy borer infestation they should be replaced. Care should be taken to see that the infestation has not progressed from them to the main part of the hull structure. Though wormshoes are usually separated from the hull by felt or copper sheathing, this separation is never 100% effective.

Marine borers die when removed from salt water for any period of time. A vessel which has been out of the water for a few days and is essentially dry will probably have no live borers.

3. Termites. Classified as a wood boring worm found principally in tropical areas, the winged variety often infest masts and wood appendages of large sailing craft, particularly those with solid (grown) spars which have developed surface checks or compression cracks.

Termites burrow deep into the wood leaving tunnels which fill with water and promote decay. Hammer testing and use of the moisture meter can often detect subsurface termite colonies. If borer infestation is suspected under canvas deck coverings or in areas where wood is covered or sheathed with metal, leather or composite overlayment, the covering should be removed to facilitate further examination.

G. CORROSION AND CATHODIC PROTECTION

1. General. Most wooden boats rely on metal fastenings for structural integrity, and those fastenings are subject to corrosion. Because of the great structural importance of the relatively small mass of metal in the fastenings, a small amount of corrosion can cause major problems, therefore, the inspection of fastenings is crucial. Many casualties to wooden vessels involving structural failures are caused by corrosion of the fastenings. Underwater metal fittings of wooden vessels (but usually not individual fastenings) are often protected electrically from corrosion by a process called cathodic protection. Wood in contact with cathodically protected fittings is often deteriorated by the chemicals produced by the protection process.

In inspecting fastenings, several fundamental facts must be kept in mind. First, most corrosion of metal fastenings in wood proceeds from the surface to the interior at a fairly constant rate which can be predicted quite accurately by experience if the metal, the temperature, and the nature of the surrounding wood are known.

Second, when a fastening is loaded in shear, like many bolts are, its strength is related to its cross-sectional area. Because the area varies as a function of the diameter, a fastening which is corroded to one-half its original diameter retains only one-quarter of its original shear strength.

Third, fastenings which are loaded in withdrawal tensile rather than in shear and which rely on threads or friction for their holding power (such as screws, lags, nails, and drifts) may lose their effectiveness completely when only a small fraction of their original diameter is lost to corrosion.

The metals used for hull fastenings in wood boats are steel (often coated with zinc, or galvanized, to increase corrosion resistance), bronzes (alloys of copper with metals other than zinc), copper, nickel-copper (Monel), stainless steels (alloys of iron with chromium and nickel), and occasionally aluminum.

Fastenings can suffer from four principal classes of corrosion - simple electrochemical corrosion, galvanic corrosion, replacement corrosion, and stray current corrosion. Stainless steel fastenings are also susceptible to a form of corrosion called crevice corrosion.

2. Simple Electrochemical Corrosion . Simple electrochemical corrosion is the normal way in which metals combine with oxygen to reach their more stable form as metallic oxides. In sea water, dissolved oxygen and chloride ions (from salt) are the principal instigators. Simple electrochemical corrosion rates are quite predictable for most metals. The process involves two different types of reactions which take place at distinct locations on the metal-water interface. An interface of metal and wet wood is the same as an interface of metal and water. At the anodes, the free electrons are absorbed in a reaction that consumes the oxygen which is dissolved in the surrounding water or in the water absorbed by the surrounding wood. In open water, the sites of the anodes and the cathodes may be microscopically small and intermixed - the metal may appear to corrode more or less uniformly. For a fastening buried in wood however, the area exposed to oxygen is often limited. The heads of fastenings tend to support oxygen consuming cathode reactions and are thus protected from wastage, while the deeper-buried shanks are where the anode reaction, and the physical wastage takes place. For this reason, exposed or shallow buried heads are often the least-corroded parts of hull fastenings. This is why hull fastenings in wooden boats cannot usually be adequately assessed without withdrawing them.
3. Galvanic Corrosion . Different metals have different levels of chemical stability in water, causing them to have different tendencies. These differences in stability are measurable as different electrical potentials, or voltages. These potentials are tabulated in the "Galvanic Series". (See Table 4-1 on page 4-17 at the end of this chapter.)

When two metals which have different potentials and which are immersed in the same body of water or wet wood are brought into direct physical contact or connected together with a metallic conductor, electric current flows between them, altering their corrosion rates from those which existed in the isolated state. The corrosion rate of the less stable metal (which had the more negative potential) increases, while that of the more stable metal (which had the more positive potential before the connection was made) decreases by an equal amount. The less stable metal is now said to be undergoing galvanic corrosion, an accelerated form of electrochemical corrosion, while the more stable metal is now receiving cathodic protection, with the other metal serving as a sacrificial anode. In order for galvanic corrosion to occur, the two different metals (dissimilar metals) must be connected electrically (by contact or by a direct metallic link, and they must be immersed in the same body of liquid or wet wood (either of which is called an electrolyte.) Two or more metals, electrically connected in a common body of electrolyte are called a galvanic cell.

Galvanized steel (steel coated with zinc) is an example of an intentional galvanic cell - the zinc acts as a sacrificial anode for the steel in the case of a small penetration of the coating. In addition, despite being less stable than steel galvanically, the zinc is considerably more

corrosion resistant than the steel when it's not acting as a sacrificial anode for a large area of steel. There's a lesson here - the Galvanic Series should be used only to predict the nature of galvanic interactions between metals - not to predict their relative corrosion rates. For example, aluminum, which is also less stable galvanically than steel, also has a lower corrosion rate than steel if it is galvanically isolated.

The ratio of the exposed areas of the two metals which make up a galvanic cell is an important factor in what happens to the metals. In the case of a cell made up of a small piece of copper (a stable metal) and a large piece of steel (an unstable metal) the corrosion rate of the steel would be only slightly increased by the connection, while the copper might be completely protected from corrosion. If the area ratio were reversed (a large area of copper to a small area of steel), the corrosion rate of the steel (already high) would be greatly increased, while the corrosion rate of the copper (already low) would be decreased only slightly. In the first case, if the copper is in contact with wood, the cathodic protection it receives comes at a price. The increased conversion of oxygen to hydroxyl ions which accompanies the protection will cause deterioration of surrounding wood. Regardless of the area ratio, painting the copper will decrease not only the adverse affect on the wood but the detrimental galvanic effect on the steel as well. Painting the steel may decrease the total galvanic effect, but will concentrate what there is at small imperfections in the paint film, causing severe localized pitting which could be disastrous to thin material found in fuel or water tanks.

In general, galvanic connections should be avoided in wooden vessels, unless they are made for a very good reason (like cathodic protection) and the consequences (like wood damage around protected metals) have been fully considered and mitigated (such as by painting the protected metals).

4. Replacement Corrosion. If a metal fitting or fastening is placed in an electrolyte which contains ions of a more stable metal, typically a galvanized steel or stainless steel fitting in pressure treated wood containing copper salts, the copper ions coming into contact with the fastening will "plate out" as a solid copper film on the surface of the fastening, with equal numbers of zinc or iron atoms ionizing, or going into solution. The replacement reaction itself is a one-for-one process, and if the stable copper ions are depleted from the electrolyte, the replacement stops. However, the thin surface coating of copper on the steel fastening results in a galvanic cell, which accelerates the fastening corrosion rate.

The three principal causes of replacement corrosion to wooden boat fastenings are, in descending order of frequency and the likelihood of significant damage:

- A. Copper wood preservative salts. These include copper naphthenate from green Cuprinol, which is usually brushed on, and chromated copper arsenate (CCA) and ammoniacal copper arsenate (ACA), which are used in pressure treating softwood lumber.
- B. Copper salts dissolved in bilgewater. Copper chloride is occasionally used as a cure for

the sour bilges (hydrogen sulfide) caused by bacterial decomposition of spilled diesel and lube oils.

C. Nearby copper-alloy fittings or fastenings . After a long period of time, wood around corroding copper alloy fittings or fastenings becomes saturated with copper ions. Any steel, galvanized steel, or stainless steel fastening driven into that area can suffer some replacement and consequent accelerated corrosion from galvanic effects. The effect only extends for a few inches at most around the copper alloy fitting, however, it's prudent not to use galvanized or stainless steel fastenings for refastening boats previously fastened with copper alloy fastenings, whether or not the original fastenings are removed.

5. Stray-Current Corrosion. Stray-current corrosion is a magnified version of the galvanic corrosion suffered by the more negative metal in a galvanic cell. In the galvanic cell, the metal is connected to another, more positive, metal, which draws electrons from it and causes the anode reaction rate of the negative metal to increase to supply those extra electrons. In stray current corrosion, a metal comes into contact with the positive side of a DC electrical system, the negative side of which is grounded to the seawater. The effect is the same, but since the driving voltage is now 12 volts or more, instead of the few tenths of a volt found in galvanic cells, the resulting corrosion rate can be catastrophic.

Typical sources of stray current are submersible bilge pumps, bilge pump float switches, and electrical wiring connections in the bilge area which might become submerged in the bilgewater. Fittings can be subject to stray current corrosion by coming into direct contact with a chafed positive (hot) DC wire or, more commonly, indirectly by a DC fault current to the bilgewater. Fittings which pass through the hull and are in contact with the outside seawater are most susceptible. In the case of an indirect stray current path through the bilgewater, fittings which are in direct contact with both the bilgewater and the outside seawater are most susceptible.

Figure C: Stray Current Corrosion

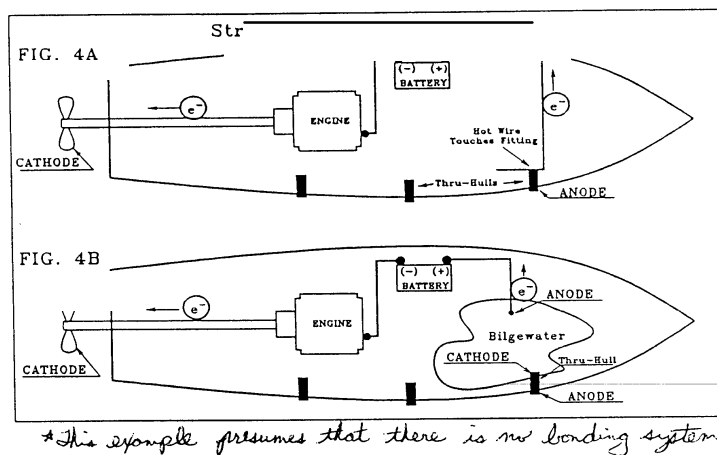

Stray current corrosion generally causes deep pitting of the objects it affects, and is almost always highly localized to within a few feet of the source of the stray current. In addition, the effected metal parts will appear to be unusually bright or shiny. A DC stray current may cause complete disintegration of a substantial fitting within a few days or even less. The magnitude of the DC stray current may be a few amps in severe cases, but usually not high enough to cause overcurrent protective devices to trip. Stray current can discharge batteries quickly, but in boats with shore-powered battery chargers, a substantial DC stray current may continue to flow indefinitely.

H. BONDING SYSTEMS

In order to protect against the potentially disastrous effects of DC stray currents, many non-metallic hulled boats have a network of wires which connect hull fittings which are at risk of stray current corrosion with the negative, or ground side of the battery, usually via the engine block. This network is called a **bonding system**. In the case of a direct fault to a bonded fitting, sufficient current will probably flow to trip the overcurrent protective device, stopping the stray current. In the case of an indirect stray current (the wire in the bilgewater), it is unlikely that a sufficient current will flow to trip the circuit, even with a bonding system. In this case the bonding system and the stray current will share the fault current. An indirect fault, however, is often limited by the corrosion of the exposed metal at the source of the fault, which eventually stifles the current flow.

Figure D: Bonding Systems

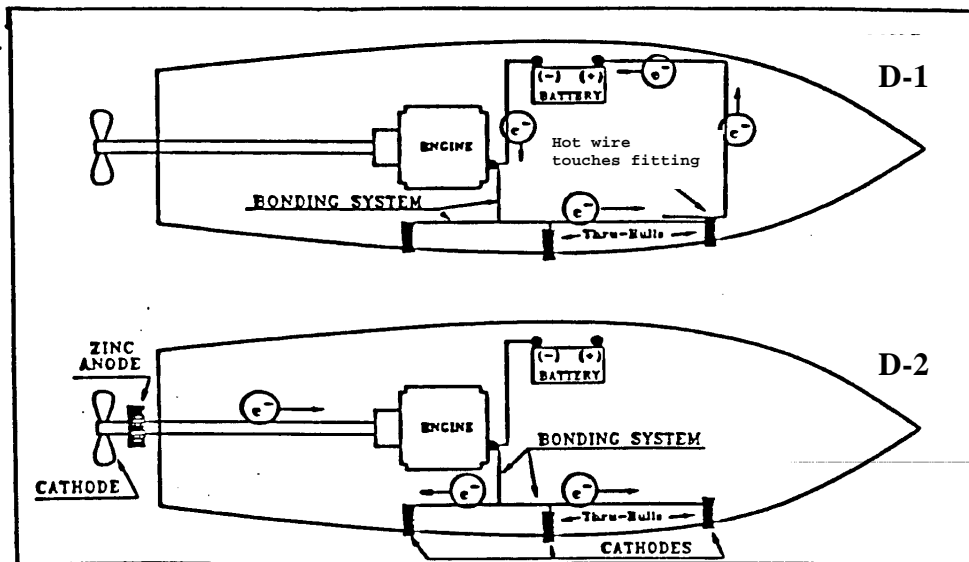

FIGURE D-1: TYPICAL BONDING SYSTEM

The bonding system ties the thru-hulls electrically to the negative terminal of the battery. When a hot wire touches the thru-hull, the electrical path presented by the bonding wire has so much less resistance than the electrolytic path of the stray-current cell that a high current flows in the

bonding system. This should cause a fuse to blow or a circuit breaker to trip, interrupting the stray current flow. Even if this does not happen, however, the amount of current that flows in the stray-current circuit before the battery becomes discharged, and the resulting corrosion of the affected fitting, are greatly diminished.

FIGURE D-2: CATHODIC PROTECTION DISTRIBUTED BY THE BONDING SYSTEM

When there are no stray currents, the shaft zinc may protect not only the shaft and prop, but also any fitting connected to the bonding system. This often results in alkali damage to the wood around those fittings.

On wooden boats, bonding systems can cause unexpected problems. First, by connecting together a number of underwater fittings and fastenings, the bonding system may provide the metallic links which turn otherwise isolated dissimilar metals into a galvanic cell. Second, the bonding system often inadvertently supplies unneeded or unwanted cathodic protection to objects connected to the bonding system by connecting those objects to the propeller shaft's sacrificial zinc anode. This cathodic protection of underwater metal hull fittings often causes damaging alkali delignification of the surrounding wood.

The fittings on a wood boat which are most susceptible to stray-current corrosion are those in the bilgewater or those which are in close physical proximity to wires, while those most susceptible to alkali delignification are those above the bilgewater level, but below the waterline. In this area the wood is wet enough to be a fairly good electrolyte, but there is little flushing action to remove accumulations of cathode reaction products. The hydroxyl ions produced by the cathode reaction on cathodically protected metals can concentrate in these locations, damaging the wood and often producing visible deposits of sodium hydroxide (lye) crystals which appear as a white mound of salt around fastenings.

Bonded vessels should be checked with a electrical potentiometer by a qualified electrical specialist for electrical leakage to ensure that the boat is not over zined. This is especially true after a vessel has been found to have extensive wood repair due to alkali deterioration. Repairing the wood, without determining the cause (via a corrosion survey) is a poor practice as it would only be treating the symptom.

I. PAINING GALVANIC CELLS

Care must be taken in painting metals which are connected galvanically to other metals. In the case of steel and copper-alloy fittings, it would seem to make sense to worry more about the coating of the steel, since it is more prone to corrosion than the copper alloy. If however, those fittings are connected together, forming a galvanic cell, painting the steel but not the copper may result in a tremendously unfavorable area ratio for a few spots on the steel that are inadvertently not coated well. When painting galvanic cells, one should always try to make the area ratio more favorable to the susceptible metal. The answer is to paint both metals, and to pay particular attention to reducing the exposed area of the cathode of the cell (the copper).

J. CREVICE CORROSION

Stainless steels are subject to a particular type of corrosion called crevice corrosion, which is a severe form of pitting. Crevice corrosion can destroy a fastening in a few years while only damaging a small fraction of the total mass of the fastening. The austenitic stainless steels (including the most commonly encountered types, 304 and 316) derive their corrosion resistance from a surface oxide film which is self-repairing in air or in the presence of oxygen dissolved in an electrolyte. In stagnant areas like wet wood or underneath marine growth or paint, however, oxygen can be depleted by cathodic activity, allowing the ever-present chloride ions to destroy the film in small areas, which then undergo unpredictable and exceedingly rapid corrosion.

Unfortunately, wet wood is a nearly perfect environment for crevice corrosion. Stainless steel must be used with great caution as a fastening material for wooden boats, and inspectors should be suspicious of all stainless steel fastenings, especially wood screws, used on boats in saltwater service. Type 316 contains more nickel and chromium than type 304, and it also contains molybdenum, which inhibits crevice corrosion to a certain extent, but it is not completely immune. Barbed or "ring" nails of type 316 are available, but wood screws of type 316 are generally not available.

K. INSPECTION OF FASTENINGS

A boat is no better than its fastenings. The most common type of fastenings found on wooden boats are screws, however, certain types of construction utilize nails, bolts or rivets. Most hull fastenings are concealed from view, being countersunk and covered; therefore their inspection is difficult.

Regardless of the type of fastenings involved, inspection to ascertain condition is necessary in most plank on frame boats.

For purposes of uniformity careful fastening inspection must be carried out on all vessels. Removal of fastenings should be conducted as follows:

1. For Cause - Saltwater And Freshwater Service . Remove fastenings whenever inspection reveals the probability of defects such as when a plank or planks are "proud" and have moved away from the frames or indications of loose bungs, rust bleeding from fastening holes etc., are noted.

Particular attention should be given to exposed hull fittings and through bolts accessible inside the hull, such as keel bolts, chine bolts, and double frame, clamp, and floor timber bolts. These are as important to the total hull structure as plank fastenings. They should be sounded with a hammer or wrench tightened and, if suspect, some should be pulled for inspection. Often a bolt will be completely wasted away in the middle, at the faying surface of the joint, and will break and come out when pried up. This is caused by moisture accumulation which, besides wasting the fastenings, forms an excellent place for wood decay to start.

2. Periodic. Inspection of fastenings can prevent planking/frame failure. Random sampling of fasteners should be part of a regular maintenance program for continuously monitoring the structural condition of the vessel. Therefore for vessels designed and built to Subchapter "T" Inspection Standards, random sampling of fastenings should begin at the 10th year of age and every 5th year thereafter in **salt water service** and 20th year of age and every 10th year thereafter in **fresh water service**.

For existing vessels not originally built to Subchapter "T" Inspection Standards but certificated later in life, random sampling should begin at the 5th year of age and every 5th year thereafter in **salt water service**, and 10th year of age and every 10th year thereafter in **fresh water service**.

Scope Of Periodic Random Sampling Of Fastenings.

- a. Remove a minimum of eight fastenings per side below the waterline.
- b. Concentrate sampling in the following areas:
 - Garboard seams
 - Stem joints
 - Plank ends in areas of bent planks
 - Shaft log(s)
 - Under engine beds where vibration is maximum
- c. In vessels of cross plank (CHESAPEAKE BAY DEADRISE) construction, specifically inspect fastenings at the keel and chine joints, at transom attachments, and over the propeller(s).

It is extremely important that the type, material, and location of the fastenings removed, along with a description of their condition be accurately documented. This includes areas of the vessel which have undergone refastening as well. Use of a camera is invaluable in recording areas of interest during inspections.

Composite, cold molded and laminar built-up wooden hulls often depend on adhesives and resins for fastening purposes. Inspection of these type vessels requires common sense and good judgement to identify the method of construction used and thereby determine the extent of inspection required. Generally, these vessels do not require periodic random sampling of fastenings by removal except for cause.

L. INSPECTION OF CAULKING

The art of caulking is an ancient one which requires experience and a certain "touch". A good caulker makes his work look easy but it is a skill which takes much experience to develop.

Caulking materials are subject to deterioration. It is advisable to search the seams in any doubtful areas and re-caulk. Caulking should be uniform and well "horsed" home. This can be checked with a probe or knife. Care should be taken that the caulking has not been driven clear through the seam. Over caulking is as bad as under caulking.

Extensive trouble with caulking may be indicative of structural problems, which often includes broken or deteriorated fastenings and/or frames. If a hull "works" excessively, caulking may be squeezed out. In such cases, the hull structure will have to be made sound before caulking will hold.

In old hulls, where the seams have become enlarged from repeated re-caulking, copper or lead strips may have been nailed over the seams to act as caulking retainers. These are a temporary remedy and are an indication of poor general condition of the vessel. It is advisable that such strips be removed and the seams inspected for excessive width, poor caulking and decay. In some cases, wide seams can be repaired by the use of thin wedge shaped splines driven into the wide seams and bedded in marine adhesive. This procedure requires excellent workmanship and should be pursued with caution. In most cases where garboard seams have widened beyond caulking limits, refastening of the keel, frames and renewal of the garboard planks may be the only acceptable methods of repair.

M. INSPECTION OF FITTINGS

Rudder and propeller struts and fastenings should be examined carefully. If suspect, random removal of fastenings for inspection should be accomplished. The steering arrangement should be inspected from the steering wheel to the heel pintle. Wear in the carrier bearing and excessive clearances elsewhere should be corrected. Tiller lines should be in good condition with shackles moused and bolts cottered.

The shaft log glands should be in good condition and the deadwood should be sound. This is often neglected and is a potential cause of leakage.

Propeller shaft cracks are sometimes found at the keyway. A careful examination here is essential. Magnetic particle testing is usually not available in a small boatyard so the inspector must depend on visually locating surface cracks. Dye penetrant testing is relatively inexpensive and can be useful when deemed necessary.

Some older boats are still fitted with AM radio hull grounding plates. These are usually copper sheet metal of several square feet in area attached to the underwater hull. Use of AM radio equipment is no longer found on small passenger vessels. To minimize the mixing of metals below the waterline, the old ground plates should be removed and the hull inspected, repaired as found necessary, and recoated.

Inspection of hardware fastenings should also be accomplished including cleats, bitts, chain plates, etc., where threaded fasteners hold load bearing as well as structural parts.

N. HULL DAMAGE

Most hull damage can be seen readily. Cracked and broken members are obvious faults.

Likely locations for cracks or breaks are in areas of high stress or where the structure undergoes a sudden change in shape. The turn of the bilge is the prime location for breaks of this type. The harder the turn, the more chance that damage has been done. Bent frames are particularly susceptible to breakage under bilge stringers, especially when the stringers are substantially thicker than the planking or when there are large diameter fastenings in the stringers.

Wood hulls are more prone to secondary damage remote from the site of collision or grounding than are steel hulls. Damage may consist of sprung butts, pulled fastenings, sprung or cracked frames and misalignment of the structure. In inspecting any damaged wooden hull, the entire vessel should be checked.

O. DEFICIENCIES

When deficiencies are encountered an evaluation must be made of their extent and their effect on seaworthiness. The following factors must be weighed in making this determination:

1. Is the defect progressive and, if so, how can its progress be arrested?
2. How long will it be before the area in question is next inspected?
3. Is the work contemplated necessary to restore seaworthiness or to prevent the vessel from becoming unseaworthy, or is it a maintenance measure to prolong the life of the vessel?

Specific requirements detailing the nature and extent of required repairs should be written. However, with wooden vessels the general rule "renew as original" while applicable, is not always practical nor necessarily the best way to effect repairs. Most accepted methods of marine repair may be used as long as the vessel's strength is not adversely affected.

Wood is a natural material, its quality cannot be controlled as closely as with a manmade product such as steel. Consequently the inspector should check the material to be used in repair work. Special attention must be given to the type of wood proposed for each purpose and for any inherent defects.

Many deficiencies, particularly surface defects or scars caused by chafing, freezing and other forms of exterior deterioration are not as serious as they may first appear. Do not be hasty in requiring the correction of minor defects of this nature in otherwise sound seasoned planking.

Requirements For Adequate Repairs Are:

1. Use of good material comparable in properties to that replaced.
2. Repairs extensive enough to ensure that the hull is at as strong as the original.
3. Construction details and fastenings at least equivalent in strength and in quality to those replaced.
4. Good workmanship.

TABLE 4-1: THE GALVANIC SERIES OF METALS IN SEAWATER

Voltages are those measured against a silver/silver chloride (Ag/AgCl) reference electrode.

<u>Noble or Cathodic Metals</u>	<u>Designation</u>	<u>Voltage Potential</u>
Graphite	C	+ 0.27 V
Platinum	Pt	+ 0.24 V
Titanium	Ti	+ 0.02 V
Incoloy 825		+ 0.02 V
Ag/AgCl Reference Electrode		0.00 V
316 Stainless Steel (passive)		- 0.03 V
Monel 70 %, 30 % cu/	400,K-500	- 0.06 V
304 Stainless Steel (passive)		- 0.06 V
Silver	Ag	- 0.10 V
Nickel	Ni	- 0.13 V
Silver Brazing Alloys		- 0.13 V
Inconel 600(passive)		- 0.13 V
Ni-Al Bronze	C63x,C954-8	- 0.16 V
Cu-Ni (70-30)	C715-9, C964	- 0.18 V
Lead	Pb	- 0.20 V
Cu-Ni (80-20 and 90-10)	C710, C706	- 0.22 V
"Nickel Silver"	C745-70, C97x	- 0.25 V
Phosphor (Tin) Bronze	C524, C903-5, C92x	- 0.26 V
Silicon Bronze	C655, C872	- 0.25 V
Manganese Bronze	C675, C86x	- 0.29 V
Admiralty Brass	C443-5	- 0.30 V
Aluminum Brass	C687-90	- 0.30 V
Lead-Tin solder		- 0.30 V
Copper	C10x, C11x, C12x	- 0.31 V
Tin	Sn	- 0.31 V
Naval Brass/"Bronze"(Tobin Bronze)	C464	- 0.33 V
Yellow and Red Brass	C23x-27x, C83x-85x	- 0.33 V
Aluminum Bronze	C606-24, C952-3	- 0.34 V
Stainless Steel 316 (active)		- 0.39 V
Stainless Steel 304 (active)		- 0.49 V
Low Alloy Steels		- 0.58 V
Steel, Cast Iron		- 0.63 V
Aluminum Alloys		- 0.87+/- .10 V
Zinc	Zn	- 1.00 V
Magnesium	Mg	- 1.60 V

All values are for sea water at room temperature.

Average variability is +/- .04 Volts for alloys containing nickel or iron, +/- .02 V for copper alloys without nickel.

Sign of corrosion potential assumes that the "COMMON" or negative (Black) terminal of the voltmeter is connected to the reference electrode and the "VOLTS-OHMS", or positive (Red) terminal is connected to the metal to be measured. The reference electrode must be immersed in the same body of electrolyte as the metal being measured, preferably in close proximity.

To use Zinc as a reference electrode instead of Ag/AgCl add +1.00 volts to the potentials listed in this table. For example, low alloy steel should measure $-.58V + 1.00V$, or $+0.42V$ against zinc, and magnesium should measure $-1.60V + 1.00V$, or $-0.60V$ against zinc. Extremely accurate measurements should not be attempted with zinc as a reference, since it isn't as stable as the Ag/AgCl electrode.

Metals are receiving cathodic protection when their measured potentials are more negative than their natural corrosion potentials listed here, and are generally completely protected from corrosion when their potentials measure .20V to .25V more negative than the values listed in this chart.

Metals are receiving stray current or are the anode of a galvanic system (these are equivalent situations) when their potentials measure more positive than the values listed in this chart. Metals in this situation are generally suffering accelerated corrosion.

Copper alloy designations: Alloys numbered C100 to C799 are wrought alloys, those numbered C800 to C999 are casting alloys. "x" indicates a range of alloys sharing the preceding digits.

CHAPTER 5: REPAIRS

A. GENERAL

Wood boat construction varies widely from locality to locality and boat to boat. All types of repairs which an inspector may encounter cannot be listed. Representative types and standards which are given here are intended as a general guide to good practice and as an aid in evaluating required repairs. Repair standards for wooden hulls should be developed for each locality on the basis of prevailing conditions and practice.

B. PLANKING REPAIR AND NOTES ON JOINTS IN FORE AND AFT PLANKING

When planking is replaced, the frames and other structures should be thoroughly inspected and placed in good condition. Holes made by old screw fastenings should be properly reamed clean and may have the cavities filled with an epoxy mixture thickened so as to provide a filler which will hold fastenings like wood. Since nail fastenings depend upon the swelling of the wood around them after they are driven for their holding power, this technique should not be used for holes made by old nail fastenings. Holes made by old nail fastenings should be properly reamed clean and filled with dowels set in a suitable adhesive.

When fastenings are loose it does little permanent good to harden up those which exist. Additional fastenings, properly placed, are the preferred repair where there is sufficient room to obtain good holding power without seriously weakening the planking or frames. If there is not room, holes in the sub-structure from the old fastenings may be repaired as noted above and new slightly oversized fastenings may be driven. Loose planking can also result from deteriorated frames and other sub-structure in which case refastening is useless unless the structure is first made sound.

Replacement fastenings should be at least equal in size, number, and of the same material as those of the rest of the planking.

Mixing fastening materials invites galvanic corrosion and should be avoided. Use of stainless steel fastenings in underwater body salt water plank fastenings can result in early fastening failure due to crevice corrosion and should also be avoided. (See Page 4-12 for details on crevice corrosion).

As a rule of thumb, the replacement plank should extend at least six frame spaces and no portion of a plank shorter than six frame spaces should be allowed to remain. Where special conditions govern, this rule may be modified but, as a lower limit, the replacement plank should be at least 5 feet long and its butts should be spaced in accordance with the rule for butts in this chapter.

When hull planking is placed on a boat, it should have the concave side of the annual rings facing toward the frame. This prevents "cupping" as the moisture content of the wood changes. Deck planking which generally sees drier service should be placed with the grain on edge or vertical. If slash grained planks are used, especially when the planking stock is not fully dried and the boat is painted a dark color, it is entirely possible that the planks will dry out in service, and the edges of planks whose ring curvature is inward will lift. Some builders, based on the moisture content of the planking and the expected service conditions, will intentionally place the concave ring curvature outward in the topsides. This is good boat building practice, and it should not be prohibited.

It is sometimes necessary to shape the inboard side of a replacement plank to fit tightly against the frames. The use of shims or packing pieces for this purpose should not ordinarily be allowed.

Flats, "dutchmen" or short lengths of planking are normally not acceptable since they will not hold fastenings and are structurally unsound.

C. DIAGONAL PLANKING

The same principles apply to diagonal planking but due to the relatively short lengths of the individual planks, a portion of a plank is seldom replaced.

Because the proper repair of double and triple diagonal planking is expensive and time consuming, short cuts involving the use of dutchmen and backing blocks are sometimes attempted. These should not be permitted. Most other planking systems follow the same basic principles of repair as outlined here. Good workmanship and care are the major requirements for proper repair. See Wooden Boat Restoration and Repair (Reference 6).

D. PLYWOOD REPAIRS

Small surface defects may be repaired using commercial fillers (epoxy putty, etc.). In allowing this type of repair the wood must be decay free and all damaged wood removed. Minor repairs of this type are satisfactory where basic strength has not been affected. The danger lies in covering up progressive defects such as decay which grow worse under the repair material.

Damaged areas up to a foot square can be successfully repaired by cutting the damaged area away in a rectangular or oval shape, installing a backing block of equal thickness as the damaged plywood, and shaping an insert piece to suit the cut-out. The repairs should be set in place with marine adhesives, i.e. Resorcinol glue or epoxy, and fastened with wood screws. Filling, fairing and coating complete the repair.

Large panel damages should be evaluated to determine if a beveled insert section can be used for the repair or if the entire panel must be replaced.

Each plywood repair must be evaluated as to cause, location, materials and strength achieved through the method selected. For detailed repair methods refer to Wooden Boat Restoration and Repair (Reference 6).

E. BUTT JOINTS IN PLANKING

Planking butts should not terminate on frames in normal construction. They should be located between frames on proper butt blocks, though in light construction with narrow strakes, they may sometimes be found as glued scarf joints at the frames and in some construction with massive framing they may be found butted on the frames. As a rule of thumb, butts in adjacent planks should be at least three frame spaces apart for transversely framed, longitudinally planked vessels.

Those butts which fall in the same frame bay should be separated by at least three solid strakes. This is not always possible, especially at the end of the vessel, but serves to illustrate the principle of keeping butts separated as much as possible. Where frame spacing is unusual the following rule may be used as a guide.

Butts in adjacent strakes should be no closer together than 5 feet. If there is a solid strake between, they should be no closer than 4 feet. Butts should be shifted so that three or more do not fall on a diagonal line.

To be effective a butt block must have adequate size (See page C-12). If the frame spacing allows, its length should be at least 12 times the planking thickness. Its thickness should be one to one and a half times the planking thickness and its width at least 1" greater than the strake width. Prior to installation it is recommended that the faying surface of the butt block and strakes be coated with a wood preservative. The top of the butt block should be curved or chamfered to allow for water run off. Avoid butting the block hard against the frames to minimize decay.

The fastenings of the strake to the butt block should be of equal strength to that of original butts. The fastening size should be equal or larger and no fewer number of fastenings should be allowed. Through bolts or machine screws are preferred fastenings in butt blocks because the joint will achieve maximum strength. Care should be exercised to avoid over tightening so as not to crush the planking or split the butt block.

Plywood butt blocks should be avoided because plywood has somewhat less strength than the "along the grain" strength of the basic wood from which it is made. Plywood is also prone to delamination and rot precipitation.

For new construction or for repairs "not in kind" the following table lists the suggested number of fastenings for planking:

Suggested **Minimum** number of fastenings for planking to butts and frames.

Width of Plank (inches)	Number of Fastenings in Butt of Each Plank	Number of Fastenings in Frame		
		1/2-1 Inch Plank Thickness	1-1 1/2 Inch Plank Thickness	1 1/2-2 Inch Plank Thickness
3-4	3	2	2	2
4-6	4	2	2	2
6-7	5	3	2	2
7-8	5	3	3	2
8-10	6	3	3	3

Glued Scarf Joints

For a glued scarf joint, the plain scarf without nibs (see Figure E) is the simplest and strongest. Water resistant glue or epoxy resin should be used and the slope of the joint should be 1/12 or flatter for maximum joint efficiency.

Scarf Slope (depth/length)	Typical Joint Efficiency for a well made glued joint without nibs
1/12	90%
1/10	85%
1/8	80%
1/5	65%

These efficiencies can be attained only with optimum adhesive conditions and excellent workmanship.

F. MECHANICALLY FASTENED SCARFS

Mechanically fastened scarf joints are most often nibbed, hooked, or keyed to provide extra axial restraint and to aid water tightness.

The surface of scarf joints should be smooth and flat to ensure good fit and adhesion.

Fastenings should be adequate in size and number and arranged so as to prevent splitting the wood.

There is considerable advantage in the use of split-ring timber connectors in mechanically fastened joints including backbone scarf joints. Timber connectors should be considered between the futtocks of full double- sawn or alternating double- sawn frames which are in line with heavy concentrations of inside or outside ballast.

Most mechanically fastened scarf joints are nibbed at the ends for a depth of approximately 15% of the depth of the member, giving a joint length of at least 6 times the depth.

A scarf joint which is fastened by mechanical means alone cannot, even under the best of conditions, produce a joint approaching a solid member in strength.

Glued Butt Joints

Glued butt joints never give joint efficiencies of over 20% and should not be permitted. Refer to THE ENCYCLOPEDIA OF WOOD (Reference 1).

Figure E: Common Forms of Scarfs

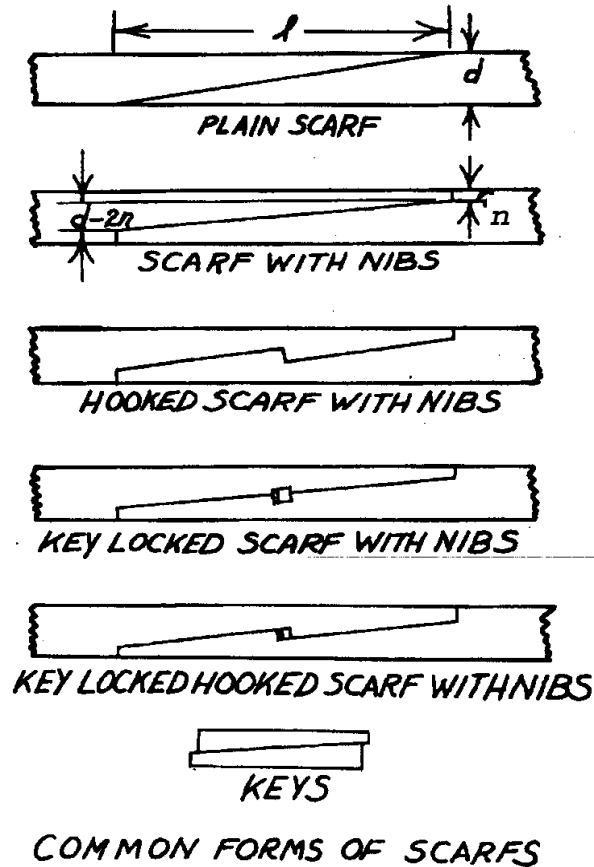

G. FRAMING REPAIRS

Sister Frames

Damage to frames can be repaired by the use of sister frames though it is preferred that the frame be replaced if practicable.

The preferred type of sister frame is one of equal size to the damaged one and as long as possible. They should extend at least 18" or approximately four plank widths beyond the damaged area. This frame should be fastened to the planking and other structure with fastenings at least equal in size and number to those of the damaged member.

Care should be taken when recommending that sister frames be of greater size than the damaged frame they reinforce. The weakening effect of bending is inversely proportional to the square of the bend ratio (see "Bent Frames", Wooden Boat No. 86, page 87.). This means that using a sister frame which is deeper (larger in molded dimension) than the original frame will produce a more severe bend ratio in the sister frame, and may actually result in the sister frames being weaker than the original frames, despite being larger. Often the original frames broke because their bend ratio was too severe in the first place. Successful sister frames may be kerfed if necessary to ease the severity of the bend when that was the problem with the original frames. This greatly increases the effective tensile strength of the sisters without any necessity for greater cross-section.

It is important to note that bending sister frames into hard spots in the hull caused by broken frames may cause locally severe bends in the sisters, which will very likely cause them to break in service. If the hard spot cannot be corrected (this usually requires removal of the original frames), it is actually better to let the sister frame bend fair, spanning the hard spot and then to shim it to the planking rather than bending it into the hard spot.

Long sister frames, well tied in to the main structure of the vessel should not normally butt against damaged frames, though this is acceptable where it forms the best method of tying in the new frame. If the frames abutt, a good bedding compound or adhesive is required to exclude moisture from between the pieces.

Where structural or machinery interference or other reasons prevent fitting a long sister frame well tied into the other structure, a shorter "partial sister" may be fitted as a temporary repair. This should extend as far as practical on both sides of the damage and should be securely fastened to the damaged frame by bolting or equivalent means as well as to the planking and other structure. Provisions should be made to exclude moisture from between the pieces. Temporary repairs of this nature should be monitored closely, followed by evaluation for consideration of further repairs or acceptance as permanent repair. Unusual or nonstandard repairs accepted as permanent should be properly documented in the vessel's permanent file.

A good wood preservative is recommended for use on all faying surfaces. Ensure that precautions are taken that water cannot accumulate at the top of the partial frame and initiate decay. A sister frame should not be used as a repair for decayed frames. The decayed wood will eventually "seed" the sound wood with decay spores in spite of any attempts to prevent it by the use of wood preservatives or to isolate the new wood with sealing compounds. When extensive decay is present in a frame the only permanent repair is to replace it and any adjacent wood affected. If the decay is localized, or such that frame replacement is not practical, the decayed section of frame may be cropped out, and replaced with a new section, using a maximum scarf angle, suitable adhesive, and by mechanically fastening the new scarf joint. A sister frame of the appropriate dimensions may then be placed next to, and centered around the new scarf joint in the original frame. This repair may be considered permanent after proper monitoring and evaluation as previously described.

Where frame damage is evident but sister framing is not practical, consideration can be given to installing interframes between the affected frames or to strengthening damaged or weakened frame areas with fitted metal frames. Such repairs require excellent design considerations and workmanship and should be undertaken with caution.

H. DECAYED FRAME HEADS

Heads of frames under covering boards often become decayed due to lack of ventilation and accumulation of fresh water leakage. With sawn frames, this can be corrected by replacing the upper futtock. If the futtock is long or the frame is in one piece, it can often be cropped off well below the rot (at least 2 feet is a good rule) and a piece spliced in using a glued and screwed scarf joint of proper dimensions. As an alternate measure a lap joint of sufficient length may replace the scarf. Repairs to more than two adjacent damaged frame heads should not be made by short cropping but should be made by renewing the frames or replacing the damaged sections by scarfing and then sistering the frame.

One of the principal causes of frame head decay is entry of water from deck leakage or condensation into the exposed end-grain at the head of the frame. This problem can be reduced greatly by angle cutting the frame tops slightly short of the underside of the deck, leaving a 1/8" to 1/4" space for ventilation, and, most importantly, by painting the end grain of the frame heads to prevent entry of moisture. The slight gap between the frame heads and the deck also ensures that if the sheer strakes should shrink slightly, the covering boards (margin planks) will not be lifted off the sheer strakes by the frame heads.

I. TREATING ISOLATED DECAY

A method which can arrest the progress of incipient decay, at least temporarily, is as follows:

The affected area is scraped clear of all decayed material and for some distance into apparently clear sound wood. A strong preservative solution, for example 1:10

pentachlorophenol stock solution, is applied freely. This is allowed to soak in and dry. Repeated applications are made until the wood refuses to take any more preservative. Often a small "cofferdam" can be made to retain a pool of preservative over the area. To be effective the preservative must sink in and sterilize the wood for a considerable distance since decay sends out spores ahead of the damaged area.

After the treatment is completed the cavity made by the scraping may be left unfilled but should be painted. Filling it will simply hide any additional rot still working.

This method is a temporary repair only. It will usually slow decay growth, but will seldom eliminate all traces of decay.

Painting of wood structures not only prevents decay, but also prevents rapid short-term changes of moisture content which result in structurally damaging dimensional changes. The proper coating of wood structures can be as important as coating of steel structures in maintaining structural integrity.

J. SHEATHING OF EXISTING WOOD HULLS

Although rejected by wood boat purists, various reinforced resin systems have been tried with some success, both as new construction methods for cold molded wood construction, and as a method to restore strength and water tightness to existing plank-on-frame constructed boats. Over the past 20 years, several systems have proven themselves successful in service, and have been recognized by local OCMI's on a case-by-case basis for certified small passenger vessels. The following guidance is provided to assist local offices in evaluating potential sheathing systems.

Improper methods of reinforced resin overlay, or overlay of an unsound structure will generally not be long lasting. This is especially true of sheathing plank-on-frame vessels whose hulls tend to flex or work. The new laminate generally has little flexibility along its length and breadth, tending to age harden and develop "tension cracks" which destroy water tightness and strength.

An evaluation should be made considering, but not limited to, the following items:

1. In the hull, even a hairline crack can allow undetected entry of marine borers.
2. With old structure which has been painted or preserved, a good bond is very difficult to attain and will require mechanical fastening in addition to the adhesive strength of the resin.
3. Any rot present will continue to grow worse under the sheathing if the proper conditions of moisture and heat develop.

4. It is difficult to acquire enough strength from a reinforced resin coating to make up that lost from an unsound substructure.
5. It is difficult to check the soundness of the substructure once the sheathing system has been applied.
6. Boats which have been sheathed may be susceptible to interior deterioration from inadequate ventilation. Evidence of visible hog or sag along the keel or sheer lines, erratic moisture meter readings or areas soft to probing should be thoroughly investigated.

There are three sheathing systems with which the Coast Guard is familiar, and that have been used on certificated small passenger vessels currently in service. They each have different methods of application which require varying degrees of hull preparation. These are:

1. Vaitses Overlay. This is a hull sheathing system developed by Alan Vaitses of Mattapoisett, Massachusetts, which uses conventional polyester resin reinforced with a lay-up of fiberglass matt and woven roving mechanically fastened with nails, wood screws or preferably heavy staples during the application. After fastening is complete, several layers of matt are applied to complete the job. This system was specifically designed for overlay of existing vessels, and has been successfully used for vessels from yachts to heavy timbered commercial fishing vessels from 20 to 50 feet long. A key feature of the Vaitses Overlay system is that it requires minimum hull preparation. Details and specific guidance on hull preparation and proper application of this method are provided in Reference #15: Covering Wooden Boats with Fiberglass .
2. W.E.S.T System Overlay. This hull sheathing system, developed by the Gougeon Brothers of Bay City, Michigan, consists of overlays of plywood or cedar strips applied diagonally to the hull, and held in place with non-corrosive staples, while fully saturated in epoxy resin. Proper wet out and temperature/humidity control are essential to achieve a good bond. Sheathing should be conducted under cover, protected from direct sunlight and wind/weather. Details and specific guidance on hull preparation and the various methods of application of this method are provided in reference #5: The Gougeon Brothers on Boat Construction and #6 Wooden Boat Restoration and Repair.
3. Fiberglass Planking System (C-FLEX). The main component of this system utilizes fiberglass rod reinforced high strength material and continuous fiberglass roving formed into 12" wide planks. This material is applied over wooden hulls perpendicular to the plank line to withstand the expansion/contraction of the wood planks, and is securely fastened to the planking with bronze staples. A moisture-cured elastomeric polyurethane adhesive designed for marine applications, which will adhere to wet wood, treated wood, and virtually all the various types of marine

planking woods, is used to bond the material to the planking. Being an elastomeric, it will withstand extreme stretch and compression forces without breaking its bond, a quality essential in preventing delamination caused by the "working" of the hull. This method requires careful hull preparation and application. Further information can be obtained by contacting Seeman Fiberglass Inc., 6117 River Road, Harahan Louisiana 70123.

Approval and use of hull sheathing systems should not be limited strictly to the above, however, the systems outlined here have demonstrated a successful operational history. Other methods must be carefully considered by the local OCMI on a case-by-case basis.

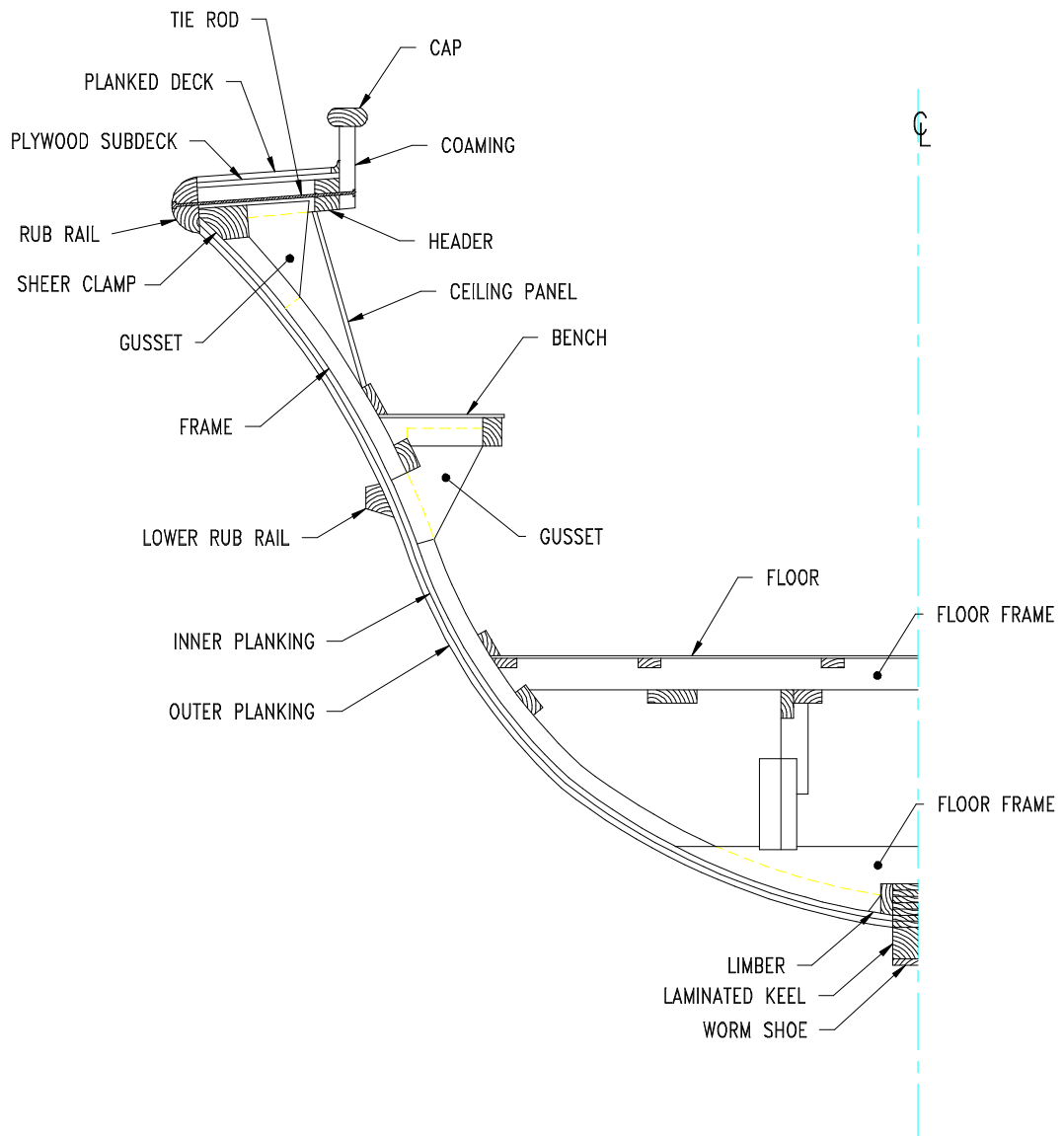

BENT FRAME, DOUBLE PLANKED	
SCALE: NTS	DRAWN BY: R.B. 10-62
DATE: 4-95	REVISED: K.F. 4-95
USCG NVIC	
FILE: DWG1.DWG	

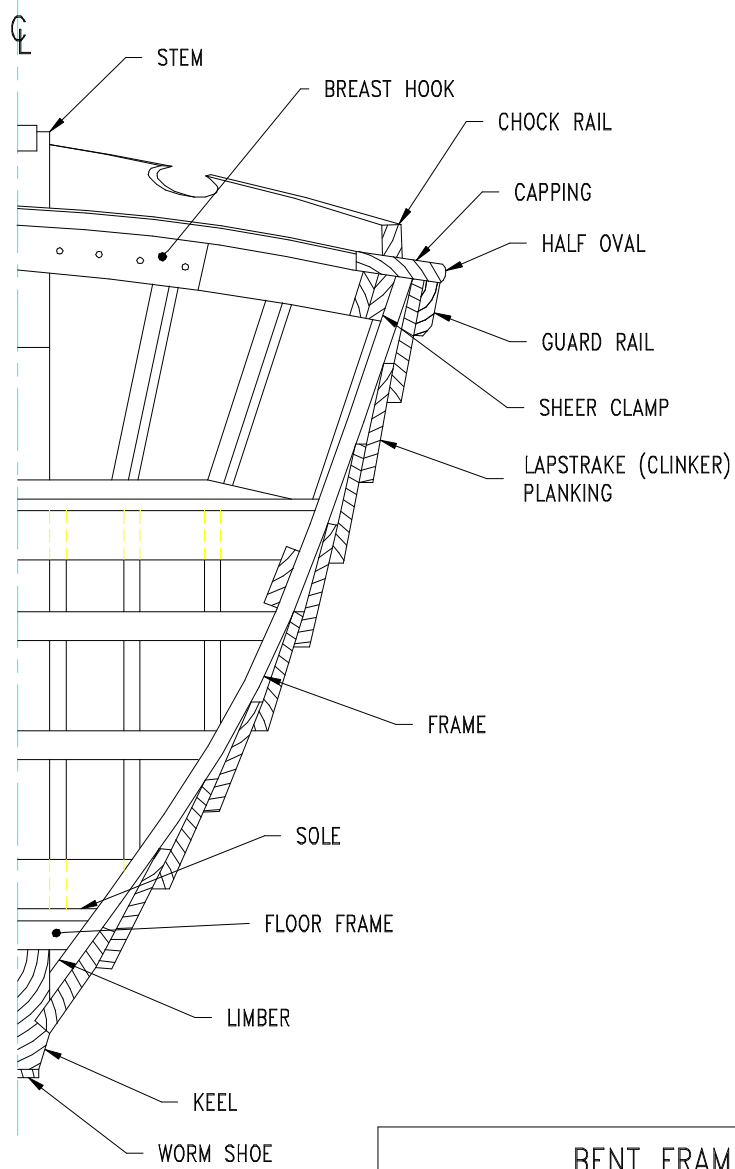

BENT FRAME, LAPSTRAKE	
SCALE: NTS	DRAWN BY: R.B. 10-62
DATE: 4-95	REVISED: K.F. 4-95
USCG NVIC	
FILE: DWG2.DWG	

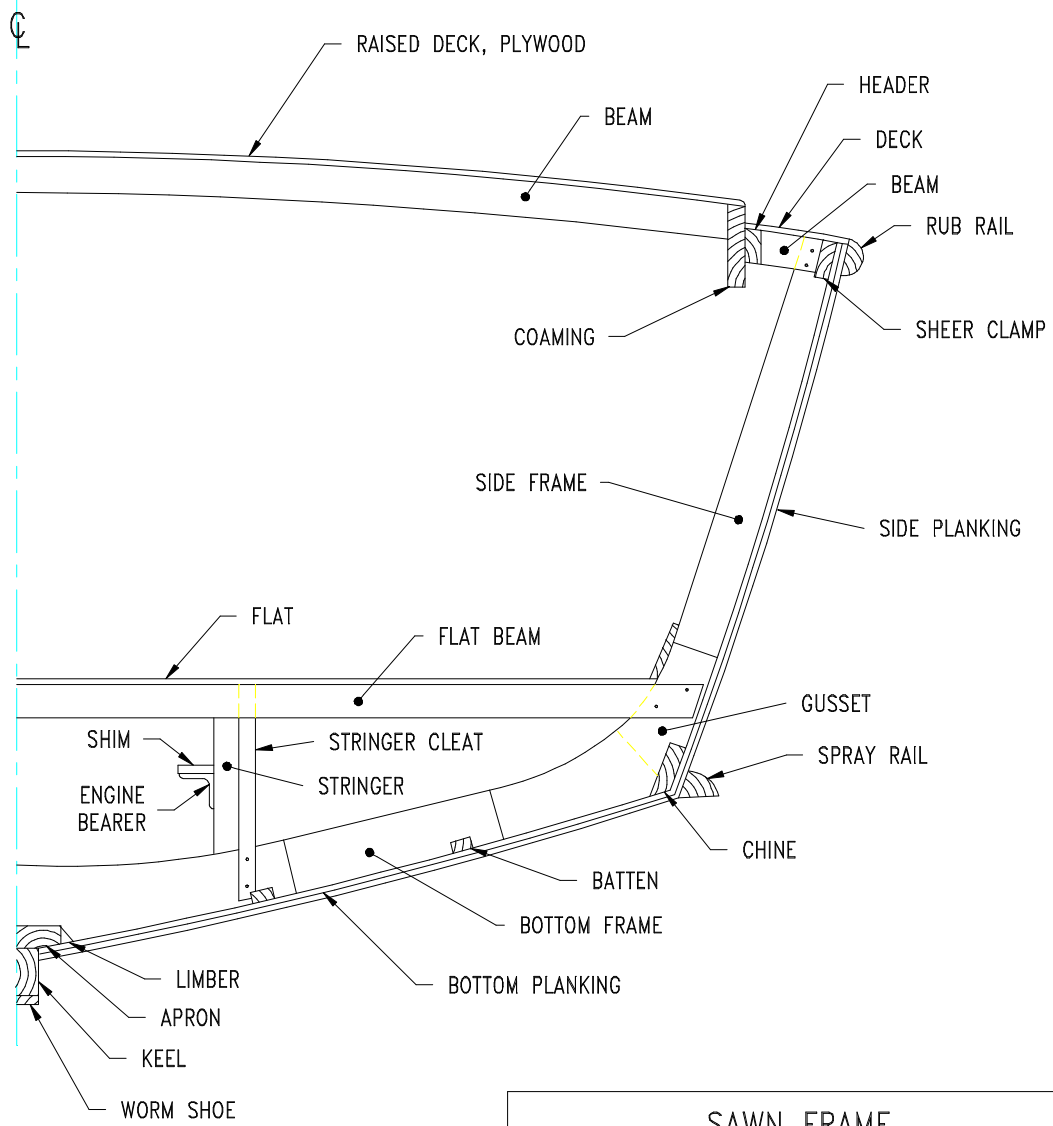

SAWN FRAME, DOUBLE PLANKED, PLYWOOD	
SCALE: NTS	DRAWN BY: R.B. 10-62
DATE: 4-95	REVISED: K.F. 4-95
USCG NVIC	
FILE: DWG3.DWG	

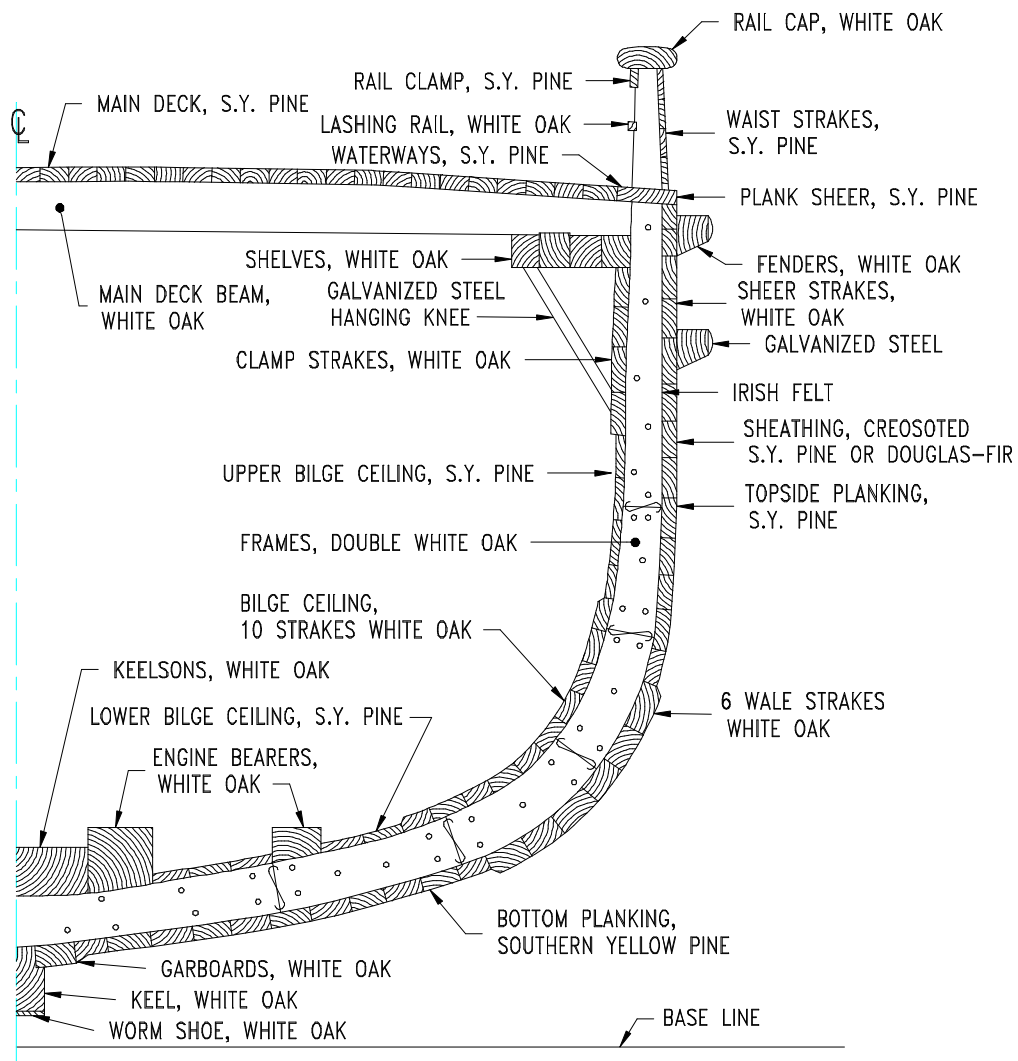

HEAVY CONSTRUCTION SECTION,
SAWN FRAME

SCALE: NTS DRAWN BY: R.B. 10-62

DATE: 4-95 REVISED: K.F. 4-95

USCG NVIC

FILE: DWG5.DWG

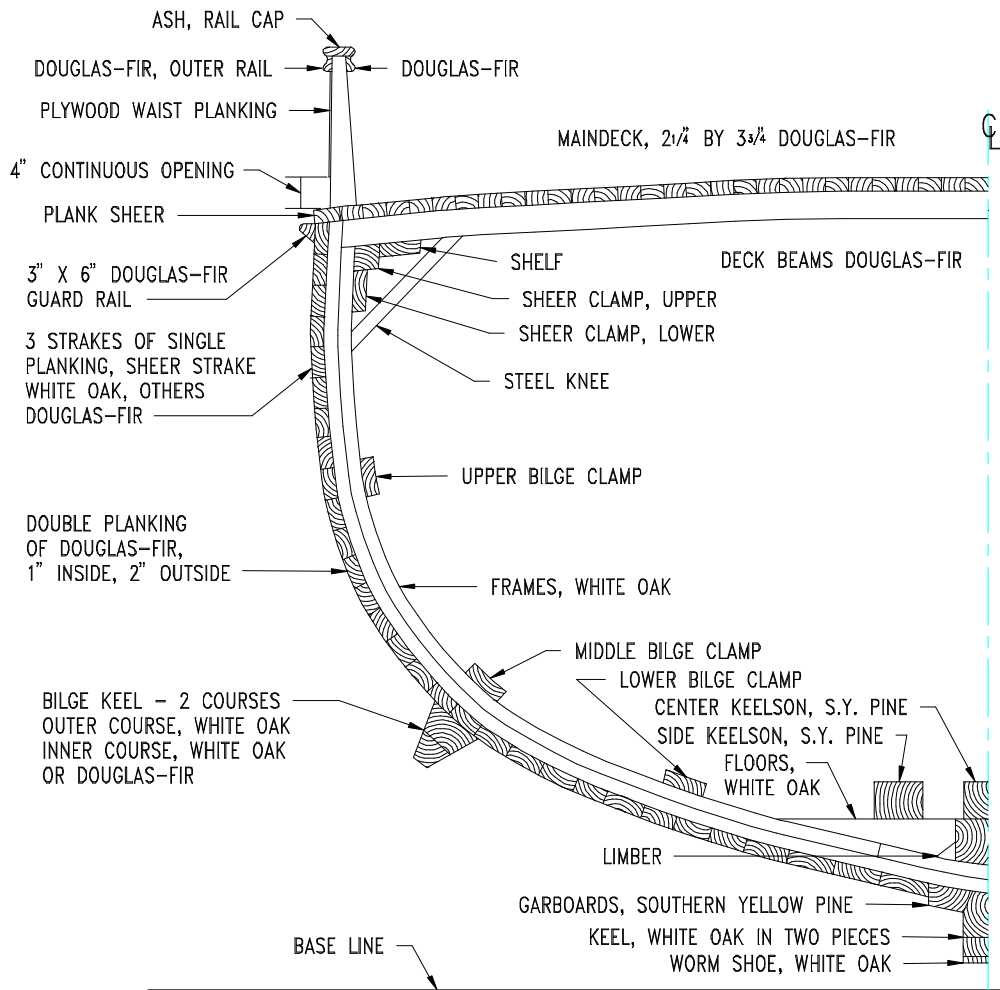

HEAVY CONSTRUCTION SECTION,
BENT FRAME

SCALE: NTS | DRAWN BY: R.B. 10-62

DATE: 4-95 | REVISED: K.F. 4-95

USCG NVIC

FILE: DWG6.DWG

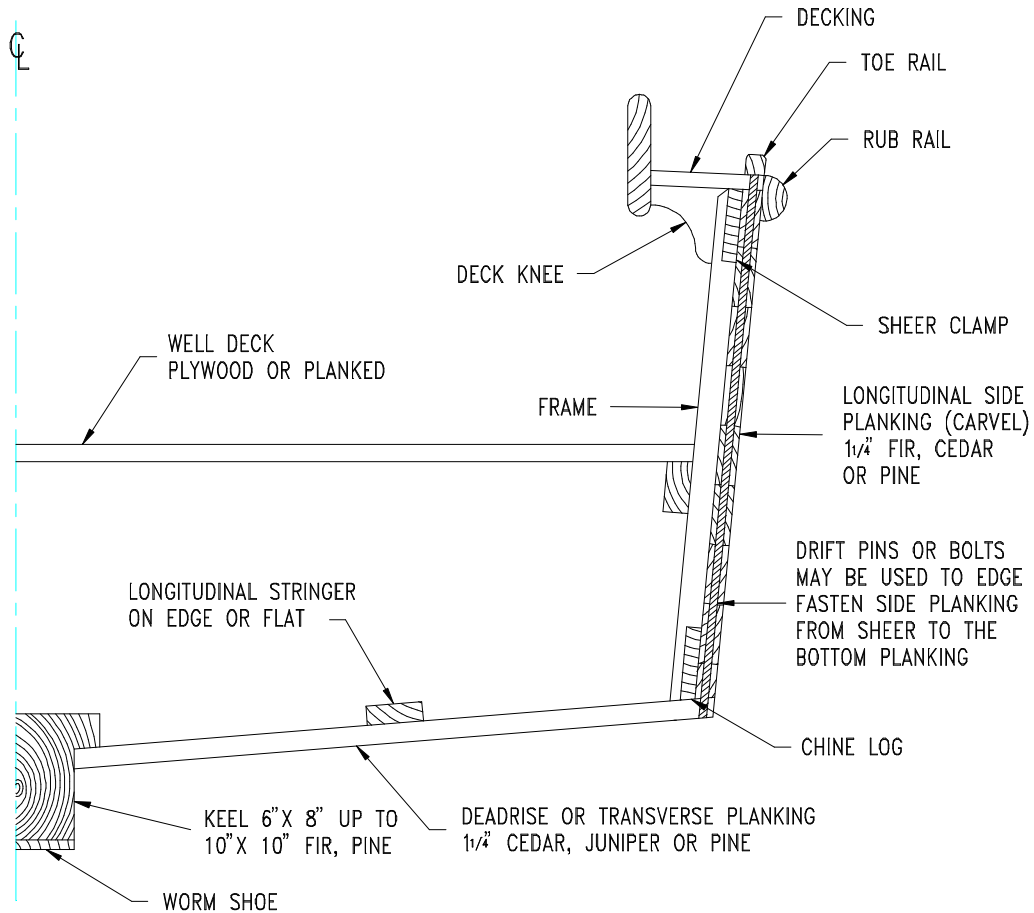

NOTE: TRANSVERSE PLANKING MAY RUN PERPENDICULAR TO THE KEEL OR IN A HERRINGBONE PATTERN SWEEPING AFT AT THE CHINES. AT THE STEM AND STERN THE PLANKING MAY BE FAN SHAPED OR RUN FORE AND AFT DEPENDING ON THE AGE OF THE BOAT AND BUILDERS PREFERENCE. (SEE BOAT BUILDING BY CHAPELLE REFERENCE 8)

CHESAPEAKE BAY DEADRISE, TRANSVERSE BOTTOM PLANKING	
SCALE: NTS	DRAWN BY: K.F. 4-95
DATE: 4-95	REVISED:
USCG NVIC	
FILE: DWG7.DWG	

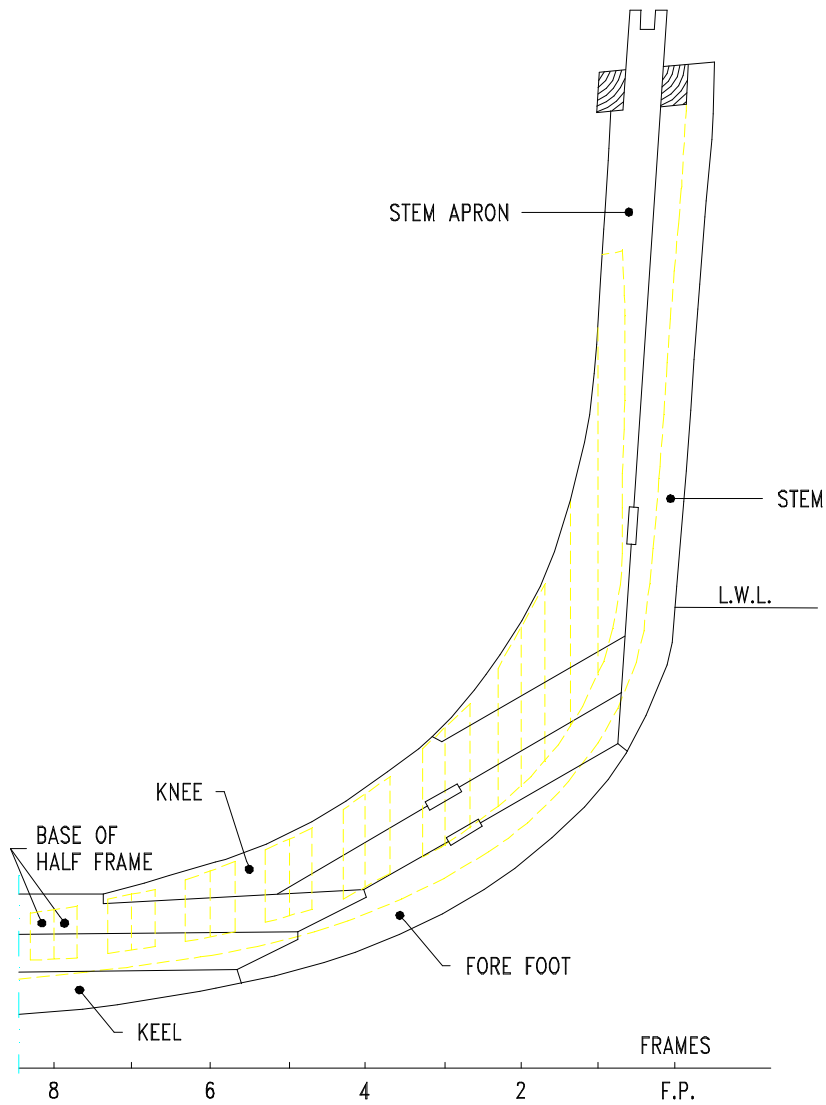

TYPICAL HEAVY STEM CONSTRUCTION	
SCALE: NTS	DRAWN BY: R.B. 10-62
DATE: 4-95	REVISED: K.F. 4-95
USCG NVIC	
FILE: DWG8.DWG	

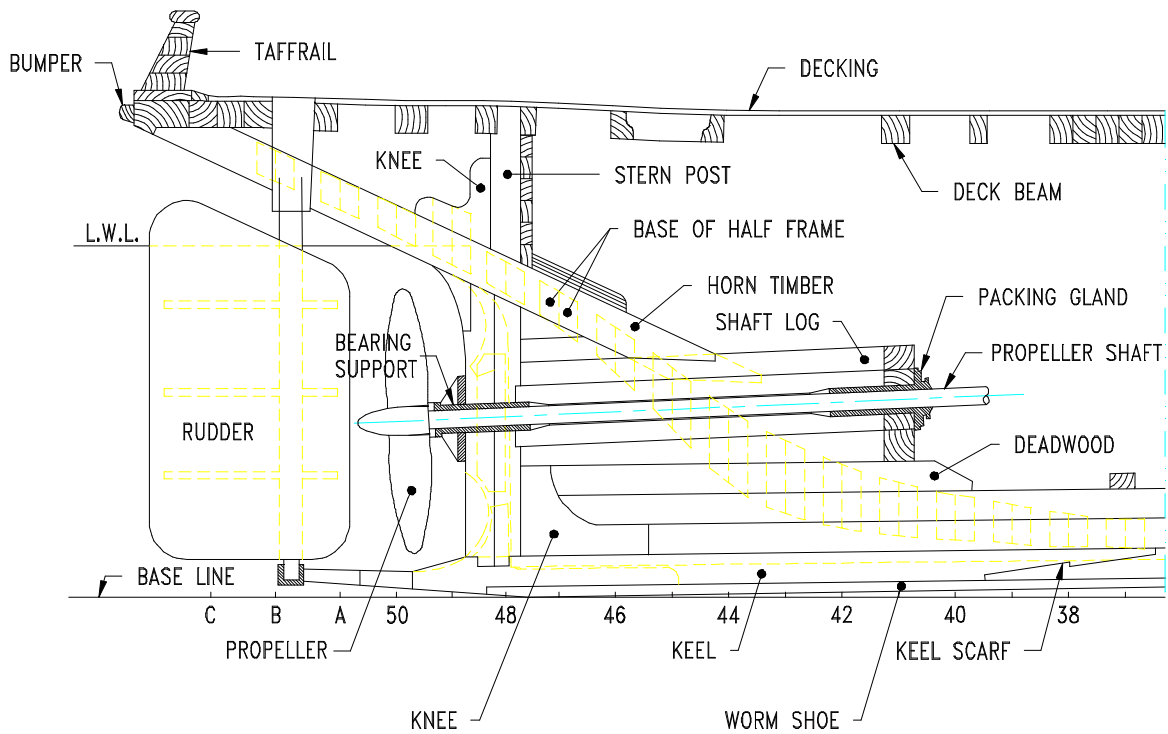

TYPICAL HEAVY STERN CONSTRUCTION	
SCALE: NTS	DRAWN BY: R.B. 10-62
DATE: 4-95	REVISED: K.F. 4-95
USCG NVIC	
FILE: DWG9.DWG	

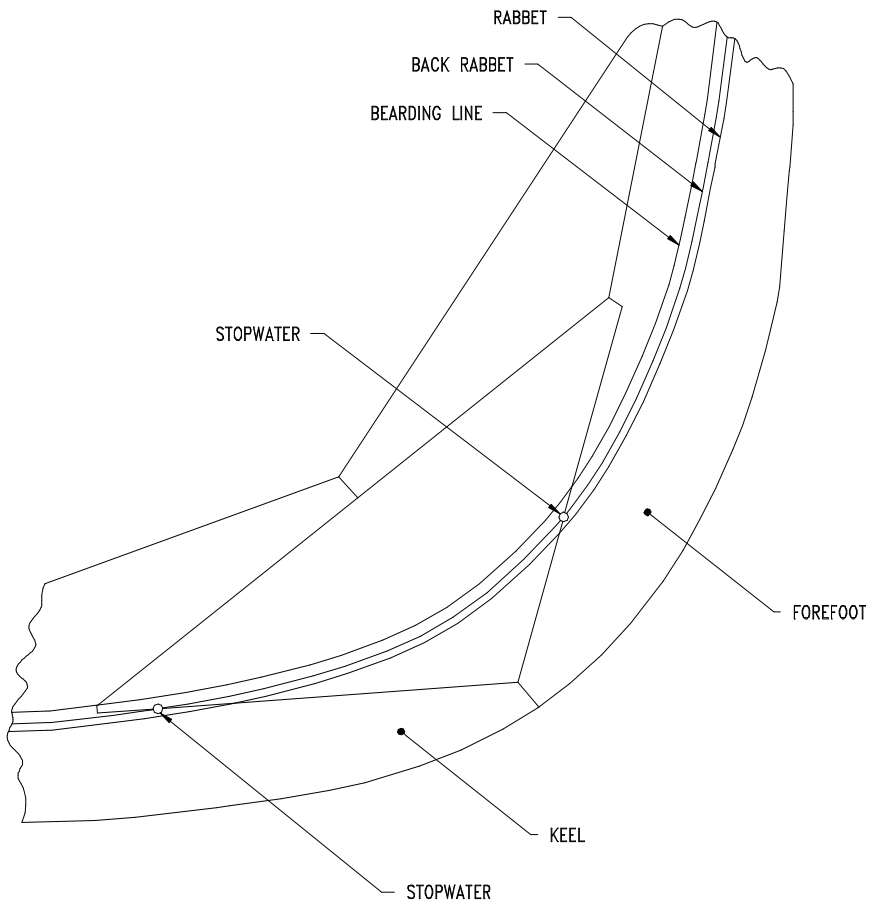

STOPWATERS IN KEEL AND FOREFOOT	
SCALE: NTS	DRAWN BY: K.F. 4-95
DATE: 4-95	REVISED:
USCG NVIC	
FILE: DWG10.DWG	

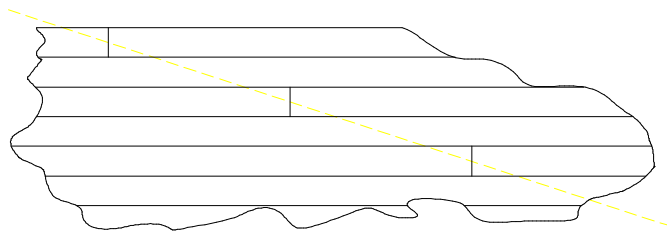
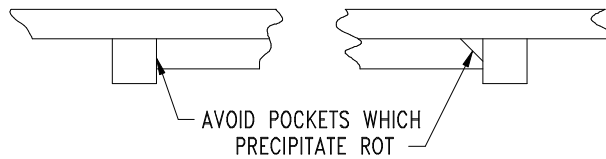
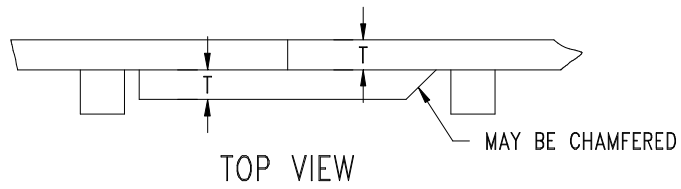
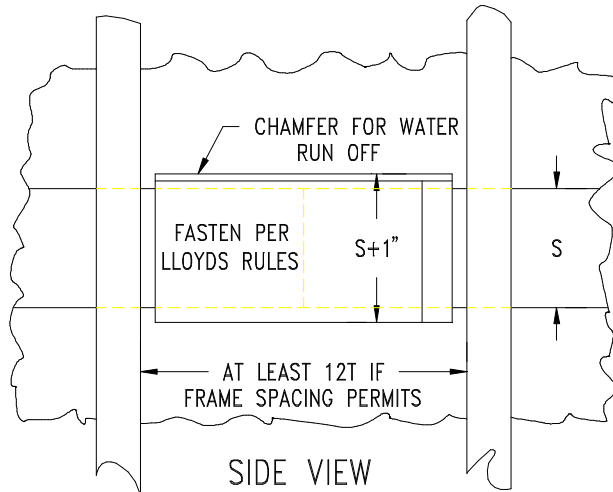

STAGGER BUTTS TO AVOID THIS SITUATION

BUTT BLOCK	
SCALE: NTS	DRAWN BY: R.B. 10-62
DATE: 4-95	REVISED: K.F. 4-95
USCG NVIC	
FILE: DWG11.DWG	